

1
1
35
63
63
106
175
175
213

6
15 15
15 15
15 15

1. 1-1
1
1

| | |
|-----|-----------|
| 001 | 1979/4/12 |
| 002 | 1981/5/18 |
| 003 | 1978/4/14 |
| 004 | 1980/7/25 |
| 005 | 1981/6/27 |
| 006 | 1981/1/18 |
| 007 | |

| | | | | | | | |
|-----|--|--|--|--|--|------------|--|
| 014 | | | | | | 1983/10/25 | |
|-----|--|--|--|--|--|------------|--|

2

Excel

14

Excel

Word

2

| | | | |
|--|----|-------|--------|
| | | | |
| | 2 | 30 | |
| | 1 | 30 40 | Office |
| | 5 | | |
| | 30 | | |
| | 30 | 2 | |

3

60

4

| | | | | |
|-------|----|--|----------|---|
| | | | | |
| (20) | 5 | | 5 | |
| | 5 | | 1 | 4 |
| | 10 | | 5 | 5 |
| (80) | 10 | | 1 1 | 0 |
| | 20 | | 1 5 5 | |

| | | | | | |
|--|--|----|--|-----------------|--|
| | | 30 | | 1 5 1 5 5 | |
| | | 20 | | 1 5 5 | |

2

1-2

1

1

| | | |
|----|----|--|
| | 30 | |
| 30 | 2 | |

3

60

4

5

(20)

|

|

002)

3.

1-3

1

1



x x

159*****135



x x

KH010101 135*****129

x x

182*****174



x x

KH010102 151*****525

2

Excel

Excel

2

| | | |
|---|----|-----------------|
| | | |
| | 2 | 30 |
| | 1 | 30 40 Office |
| 5 | | |
| | 30 | |
| | 30 | 2 |

3

60

4

| | | | | |
|-------|----|--|---|---|
| | | | | |
| (20) | 5 | | 5 | |
| | 5 | | 1 | 4 |
| | 10 | | | 5 |

| | | | | | |
|-------|--|----|--|------------|---|
| | | | | 5 | 0 |
| (80) | | 30 | | 1 5 1 5 | |
| | | 20 | | 1 1 | |
| | | 30 | | 1 5 1 5 | |

4.

1-4

1

1

2

Excel

Excel

2

| | | |
|---|----|-----------------|
| | | |
| | 2 | 30 |
| | 1 | 30 40 Office |
| 5 | | |
| | 30 | |
| | 30 | 2 |

3

60

4

| | | | |
|--|---|--|---|
| | | | |
| | 5 | | 5 |

(20)

5

0

1

30 40

Office

5

30

30

2

6.

1-6

1

1

2014 6 10

001

| | | | |
|--|----|-------|--------|
| | 2 | 30 | |
| | 1 | 30 40 | Office |
| | 5 | | |
| | 30 | | |
| | 30 | 2 | |

3

60

4

| | | | | |
|-------|----|--|-------------|---|
| | | | | |
| (20) | 5 | | 5 | 0 |
| | 5 | | 1 | |
| | 10 | | 4 5 5 | |
| (80) | 20 | | 1 5 1 5 | |
| | 30 | | 1 5 1 5 | |
| | 30 | | 5 | |

7. 1-7

1

1

1

| | | | | | | | |
|--|---------|--|-------|--|----|--|-----|
| | 0730206 | | 6 | | | | 150 |
| | 73 | | 10950 | | 68 | | |

2

| | | | | | | | |
|--|---------|--|-------|--|----|--|-----|
| | 0730201 | | 1 | | | | 200 |
| | 95 | | 19000 | | 48 | | |

3

| | | | | | | | |
|--|---------|--|-------|--|----|--|-----|
| | 0730204 | | 4 | | | | 180 |
| | 74 | | 13320 | | 14 | | |

2

Excel

" " " " " " "

Excel

2

| | | | | | | |
|--|---|----|---|----|----|--------|
| | | | | | | |
| | | 2 | | 30 | | |
| | | | 1 | 30 | 40 | Office |
| | 5 | | | | | |
| | | 30 | | | | |

| | | | |
|--|----|---|--|
| | 30 | 2 | |
|--|----|---|--|

3

60

4

| | | | | |
|-------|----|--|------------|---|
| | | | | |
| (20) | 5 | | 5 | 0 |
| | 5 | | 1 4 | |
| | 10 | | 5 5 | |
| (80) | 30 | | 1 5 1 5 | |
| | 20 | | 1 1 | |
| | 30 | | 1 5 1 5 | |

8.

1-8

1

1

| | | A | B | C | | |
|----------|--|-----|-----|-----|--|--|
| 20041001 | | 175 | 285 | 120 | | |
| 20041002 | | 99 | 175 | 164 | | |
| 20041003 | | 158 | 169 | 275 | | |
| 20041004 | | 244 | 190 | 191 | | |
| 20041005 | | 184 | 287 | 188 | | |
| 20041006 | | 172 | 268 | 285 | | |
| 20041007 | | 185 | 271 | 176 | | |
| 20041008 | | 288 | 185 | 275 | | |
| 20041009 | | 178 | 280 | 176 | | |
| 20041010 | | 194 | 287 | 282 | | |
| 20041011 | | 260 | 76 | 271 | | |

2

Excel

100

200

100

200

300

Excel

Excel

2

| | | |
|--|---|----|
| | | |
| | 2 | 30 |

| | | | | |
|--|----|----|----|--------|
| | 1 | 30 | 40 | Office |
| | 5 | | | |
| | | 30 | | |
| | 30 | 2 | | |

3

60

4

| | | | | |
|-------|----|--|---|---|
| | | | | |
| (20) | 5 | | 5 | |
| | 5 | | 1 | 4 |
| | 10 | | 5 | 5 |
| | | | 5 | 0 |
| (80) | 20 | | 1 | 1 |
| | 20 | | 1 | 5 |
| | 20 | | 1 | 5 |
| | 20 | | 1 | 5 |

9.

1-9

1

1

2014 1 5

A. 0***3

50

30

5500

2

Excel

Excel

2

| | | |
|--|----|-----------------|
| | | |
| | 2 | 30 |
| | 1 | 30 40 Office |
| | 5 | |
| | 30 | |
| | 30 | 2 |

3

60

4

| | | | | | | |
|-------|--|----|--|---|---|---|
| (20) | | 5 | | 1 | | 0 |
| | | | | | 4 | |
| (80) | | 10 | | | 5 | |
| | | | | 5 | | |
| (80) | | 30 | | 1 | 5 | |
| | | | | 1 | 5 | |
| | | 20 | | 1 | 1 | |
| | | 30 | | 1 | 5 | |
| | | | | 1 | 5 | |

10.

1-10

1

1

2014 9 18

A. 4***8

**

15928***135

15 2014 10 10

H20140918

| | | | |
|---|-------|-----|--------|
| | | | |
| 1 | 24 / | 100 | 64.50 |
| 2 | 50 / | 100 | 72.50 |
| 1 | 50kg/ | 150 | 120.00 |
| 2 | 50kg/ | 150 | 140.00 |
| 1 | 24 / | 200 | 90.00 |
| 2 | 50 / | 200 | 110.00 |

2

Excel

Excel

2

| | | |
|--|--|--|
| | | |
|--|--|--|

| | | | |
|--|----|-------|--------|
| | 2 | 30 | |
| | 1 | 30 40 | Office |
| | 5 | | |
| | 30 | | |
| | 30 | 2 | |

3

60

4

| | | | | |
|-------|----|--|------------|---|
| | | | | |
| (20) | 5 | | 5 | 0 |
| | 5 | | 1 | |
| | 10 | | 4 | |
| (80) | 30 | | 5 | 0 |
| | 30 | | 1 5 1 5 | |
| | 20 | | 1 1 | |
| | 30 | | 1 5 1 5 | |

11.

1-11

1

1

2014 9 15

D20134091006

159*****135

2

Excel

Excel

2

| | | |
|----|----|-----------------|
| | | |
| | 2 | 30 |
| | 1 | 30 40 Office |
| 5 | | |
| | 30 | |
| 30 | 2 | |

3

60

4

| | | | |
|--|---|--|---|
| | | | |
| | 5 | | 5 |

| | | | | | | |
|-------|--|----|--|------------|--|---|
| (20) | | 5 | | 1 | | 0 |
| | | | | 4 | | |
| (80) | | 10 | | 5 | | |
| | | | | 5 | | |
| | | 30 | | 1 5 1 5 | | |
| (80) | | 20 | | 1 1 | | |
| | | 30 | | 5 | | |

12

1-12

1

1

| | | | | | | | | | |
|--|-----------|-----------|-----------|----------|----------|----------|----------|--|--|
| | | | | | | | | | |
| | 40,000.00 | 12,500.00 | 10,000.00 | 2,000.00 | 3,000.00 | 1,200.00 | 500.00 | | |
| | 60,000.00 | 35,000.00 | 20,000.00 | 2,000.00 | 2,800.00 | 3,000.00 | 1,000.00 | | |
| | 30,000.00 | 14,000.00 | 8,500.00 | 1,000.00 | 2,650.00 | 1,000.00 | 800.00 | | |
| | 70,000.00 | 35,000.00 | 10,000.00 | 1,000.00 | 2,400.00 | 1,200.00 | 500.00 | | |
| | 60,000.00 | 34,000.00 | 9,500.00 | 1,000.00 | 3,000.00 | 1,000.00 | 600.00 | | |
| | 20,000.00 | 10,000.00 | 7,500.00 | 2,000.00 | 2,700.00 | 1,000.00 | 1,200.00 | | |
| | 40,000.00 | 23,000.00 | 12,000.00 | 1,000.00 | 3,100.00 | 1,000.00 | 900.00 | | |
| | 50,000.00 | 25,000.00 | 14,000.00 | 2,000.00 | 2,900.00 | 1,000.00 | 700.00 | | |

2

Excel

Word

IF

Excel

Excel

Word

2

| | | |
|--|----|-----------------|
| | | |
| | 2 | 30 |
| | 1 | 30 40 Office |
| | 5 | |
| | 30 | |
| | 30 | 2 |

3

60

4

| | | | | |
|-------|----|--|------------|---|
| | | | | |
| (20) | 5 | | 5 | 0 |
| | 5 | | 1 4 | |
| | 10 | | 5 5 | |
| (80) | 10 | | 1 1 | |
| | 20 | | 1 5 5 | |
| | 30 | | 1 5 1 5 | |
| | 20 | | 1 5 5 | |

13.

1-13

1

1

| | | | | | | | | |
|----|-----------|-----|---|----|-------|--|--|--|
| | | | | | | | | |
| 1 | 2013/6/12 | x x | 1 | 10 | 23.00 | | | |
| 2 | 2013/6/12 | x x | 3 | 12 | 42.00 | | | |
| 3 | 2013/6/12 | x x | 1 | 4 | 45.00 | | | |
| 4 | 2013/6/15 | x x | 2 | 24 | 41.00 | | | |
| 5 | 2013/6/15 | x x | 3 | 25 | 32.00 | | | |
| 6 | 2013/6/15 | x x | 1 | 40 | 8.00 | | | |
| 7 | 2013/6/15 | x x | 2 | 20 | 12.00 | | | |
| 8 | 2013/6/19 | x x | 1 | 5 | 23.00 | | | |
| 9 | 2013/6/20 | x x | 2 | 10 | 31.00 | | | |
| 10 | 2013/6/21 | x x | 3 | 18 | 15.00 | | | |

2

Excel

Word

Excel

Excel

Word

2

| | | |
|--|----|-----------------|
| | | |
| | 2 | 30 |
| | 1 | 30 40 Office |
| | 5 | |
| | 30 | |
| | 30 | 2 |

3

60

4

| | | | | |
|-------|----|--|------------|---|
| | | | | |
| (20) | 5 | | 5 | 0 |
| | 5 | | 1 4 | |
| | 10 | | 5 5 | |
| (80) | 10 | | 1 1 | |
| | 10 | | 1 5 5 | |
| | 20 | | 1 5 1 5 | |
| | 20 | | 1 5 1 5 | |

| | | | | | |
|--|--|----|--|----------|--|
| | | 20 | | 1 5 5 | |
|--|--|----|--|----------|--|

14.

1-14

1

1

| | | | |
|-----------|------|-----|-----|
| YC2012001 | | 399 | 273 |
| YC2012002 | VI P | 546 | 234 |
| YC2012003 | | 700 | 282 |
| YC2012004 | | 357 | 288 |
| YC2012005 | | 385 | 183 |
| YC2012006 | | 644 | 213 |
| YC2012007 | VI P | 455 | 285 |
| YC2012008 | | 385 | 183 |
| YC2012009 | | 504 | 400 |
| YC2012010 | | 588 | 237 |
| YC2012018 | | 665 | 198 |
| YC2012019 | | 700 | 282 |
| YC2012020 | | 469 | 282 |
| YC2012021 | VI P | 378 | 210 |
| YC2012022 | | 665 | 204 |
| R04 | | | |

Excel

Excel

Word

2

| | | |
|--|----|-----------------|
| | | |
| | 2 | 30 |
| | 1 | 30 40 Office |
| | 5 | |
| | 30 | |
| | 30 | 2 |

3

60

4

| | | | | |
|-------|----|--|------------|---|
| | | | | |
| (20) | 5 | | 5 | 0 |
| | 5 | | 1 4 | |
| | 10 | | 5 5 | |
| (80) | 10 | | 1 1 | |
| | 10 | | 1 5 5 | |
| | 20 | | 1 5 1 5 | |

| | | | | | |
|--|--|----|--|--------------|--|
| | | | | 5 | |
| | | 20 | | 1 5 1 5 , | |
| | | 20 | | 1 5 5 | |

15.

1-15

1

1

| | | | | |
|----------|----------|----------|-----------|----------|
| 93,076.4 | 92,064.7 | 67,783.9 | 101,170.0 | 77,900.9 |
| 70,819.0 | 64,748.8 | 83,971.1 | 94,088.1 | 88,017.9 |
| 58,678.6 | 51,596.7 | 83,971.1 | 55,643.5 | 91,053.0 |
| 73,854.1 | 54,631.8 | 83,971.1 | 53,620.1 | 96,111.5 |
| 76,889.2 | 59,690.3 | 83,971.1 | 70,819.0 | 91,053.0 |
| 88,017.9 | 56,655.2 | 83,971.1 | 53,620.1 | 76,889.2 |
| 59,690.3 | 98,134.9 | 83,971.1 | 83,971.1 | 52,608.4 |
| 59,690.3 | 95,099.8 | 83,971.1 | 94,088.1 | 88,017.9 |

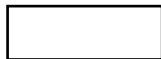

1

Excel

Word

40% 30% 30%

10

100.0%

20.0%

120.0%

/

Excel

10

Excel

Word

2

| | | |
|----|----|-----------------|
| | | |
| | 2 | 30 |
| | 1 | 30 40 Office |
| 5 | | |
| | 30 | |
| 30 | 2 | |

3

60

4

| | | | | |
|--|--|--|--|--|
| | | | | |
|--|--|--|--|--|

| | | | | |
|-------|----|--|---|---|
| (20) | 5 | | 5 | |
| | 5 | | 1 | 4 |
| | 10 | | 5 | 5 |
| | | | 5 | 0 |
| (80) | 10 | | 1 | 1 |
| | 10 | | 1 | 5 |
| | 20 | | 5 | 5 |
| | 20 | | 1 | 5 |
| | 20 | | 1 | 5 |
| | 20 | | 1 | 5 |
| | | | 5 | |

1.

2-1

1

1

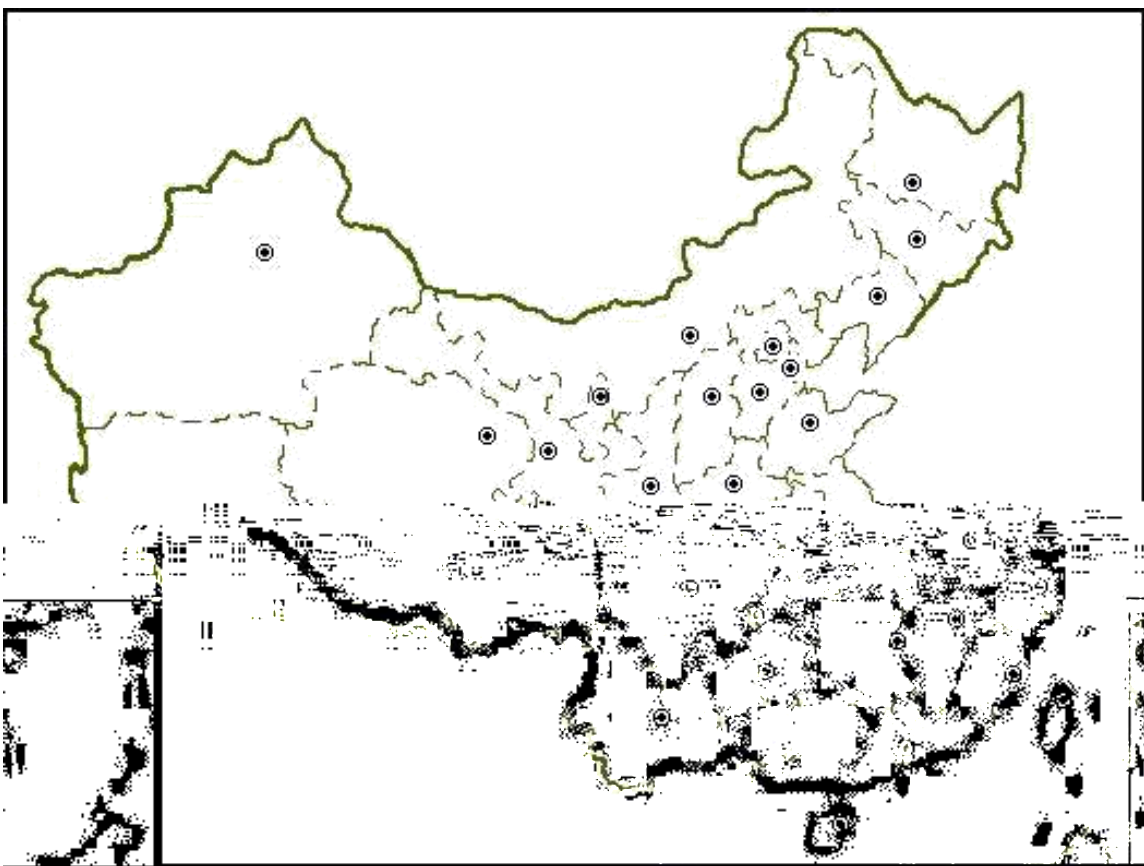

2

" "

Word

2

| | | | |
|--|----|----|-----------------|
| | | | |
| | | 2 | 30 |
| | | 1 | 30 40 Office |
| | 5 | | |
| | | 30 | |
| | 30 | 2 | |

3

60

4

| | | | | |
|-------|--|----|--|------------|
| | | | | |
| (20) | | 5 | | 5 |
| | | 5 | | 1 4 |
| | | 10 | | 5 5 |
| (80) | | 30 | | 1 2 1 2 |
| | | 30 | | 1 2 1 2 |
| | | 20 | | 1 2 1 2 |
| | | | | 0 |

2

2-2

1

1



2

2-3

400

Word

2

| | | |
|--|----|-----------------|
| | | |
| | 2 | 30 |
| | 1 | 30 40 Office |
| | 5 | |
| | 30 | |
| | 30 | 2 |

3

60

4

| | | | | |
|-------|----|-----|--------------|---|
| | | | | |
| (20) | 5 | | 5 | 0 |
| | 5 | | 1 4 | |
| | 10 | | 5 5 | |
| (80) | 20 | | 1 2 1 2 | |
| | 20 | | 1 2 1 2 | |
| | 20 | 3-5 | 1 2 3 1 2 | |
| | 20 | | 2 | |

3.

2-3

1

1

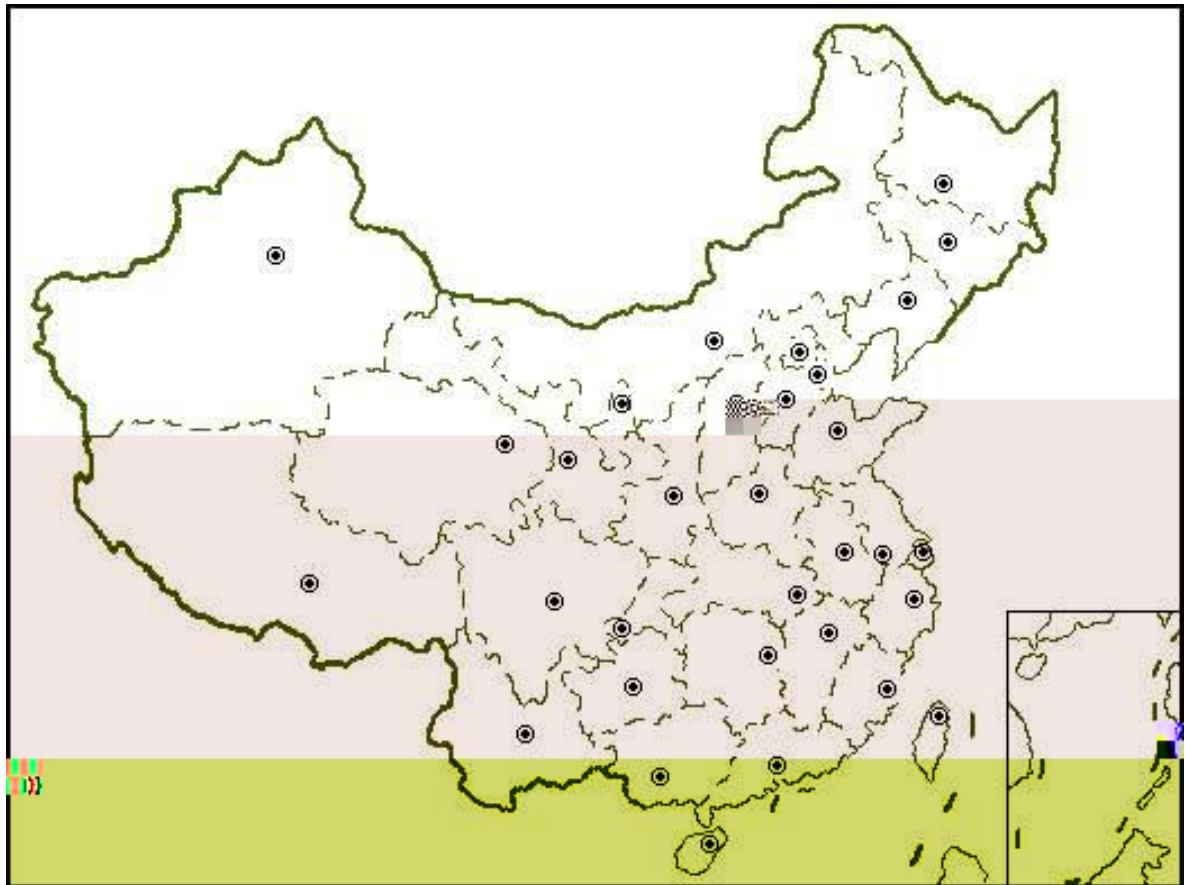

2

" "

" "

3-5

400

Wörd

2

| | | |
|--|----|-----------------|
| | | |
| | 2 | 30 |
| | 1 | 30 40 Office |
| | 5 | |
| | 30 | |
| | 30 | 2 |

3

60

4

| | | | | |
|-------|----|-----|-----------------|---|
| | | | | |
| (20) | 5 | | 5 | 0 |
| | 5 | | 1 4 | |
| | 10 | | 5 5 | |
| (80) | 20 | | 1 2 1 2 | |
| | 20 | | 1 2 1 2 | |
| | 20 | 3-5 | 2 1 2 3 | |
| | 20 | | 1 2 10 10 | |

4.

2-4

1

1

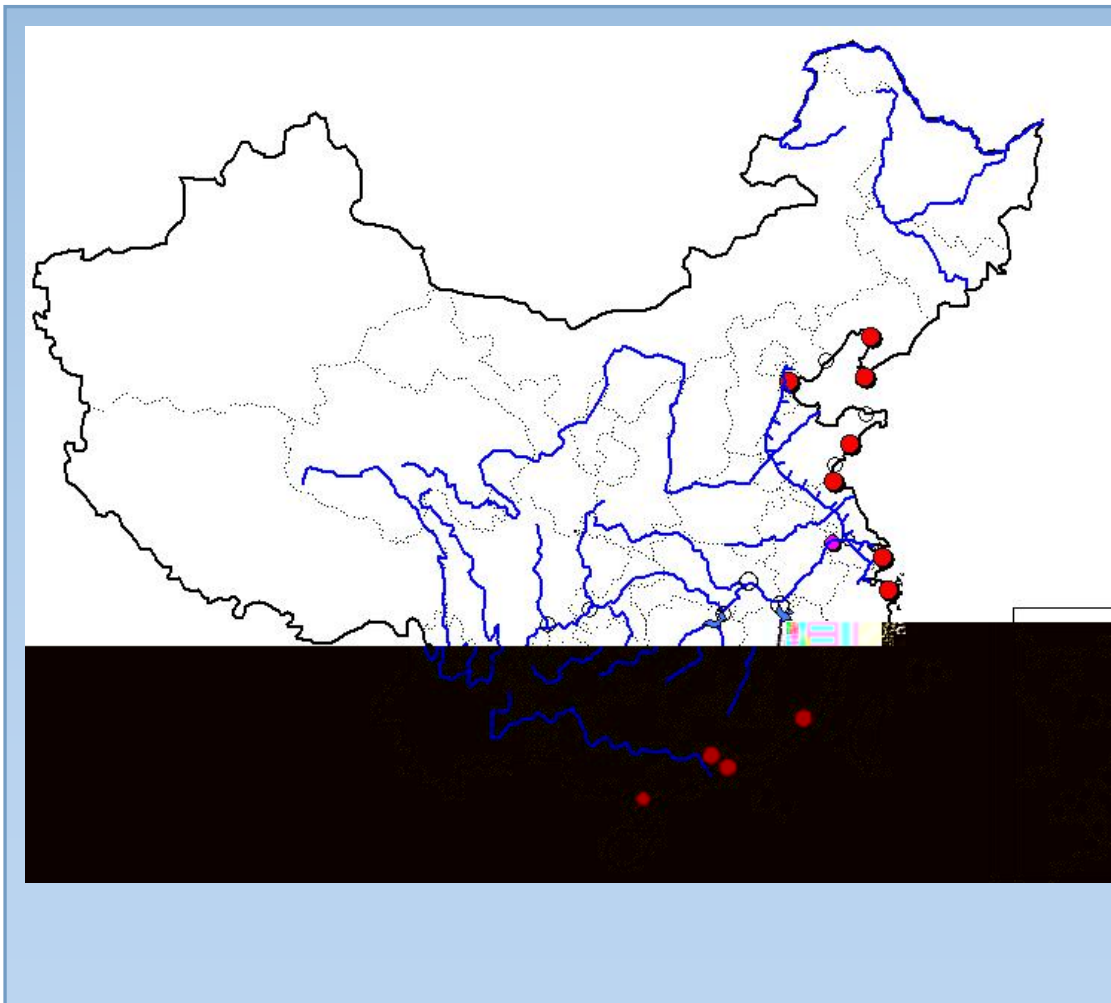

2

Word

2

2

30

1

30 40

Office

5

30

30

2

.

5.

2-5

1

1

30

3

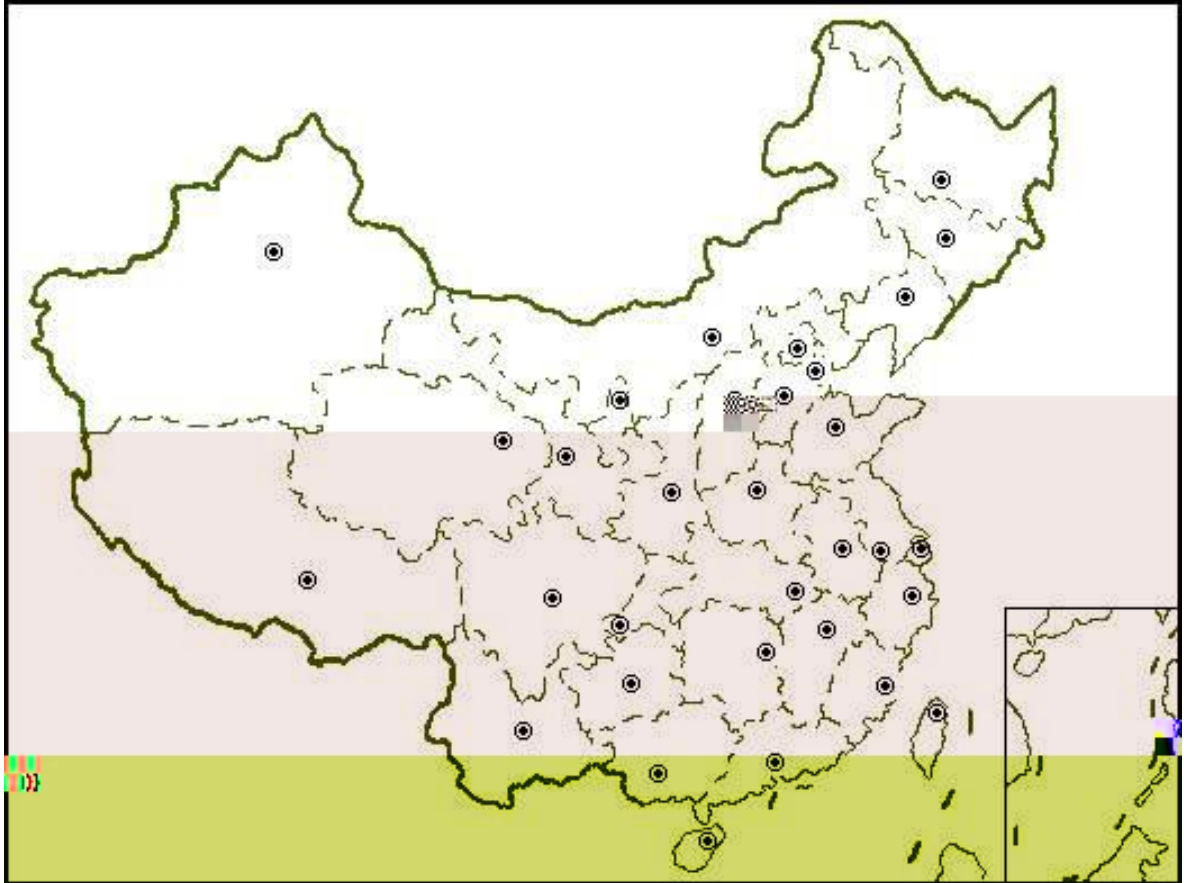

2

3-5

Word

2

| | | |
|--|---|----|
| | | |
| | 2 | 30 |

| | | | | |
|--|----|----|----|--------|
| | 1 | 30 | 40 | Office |
| | 5 | | | |
| | | 30 | | |
| | 30 | 2 | | |

3

60

4

| | | | | |
|-------|----|-----|---|---|
| | | | | |
| (20) | 5 | | 5 | |
| | 5 | | 1 | |
| | 10 | | 4 | |
| (80) | 10 | | 5 | 0 |
| | 20 | | 5 | 5 |
| | 10 | | 1 | 2 |
| | 20 | | 1 | 5 |
| | 10 | 3-5 | 1 | 5 |
| | 20 | | 1 | 5 |

6.

2-6

1

1

2000

14

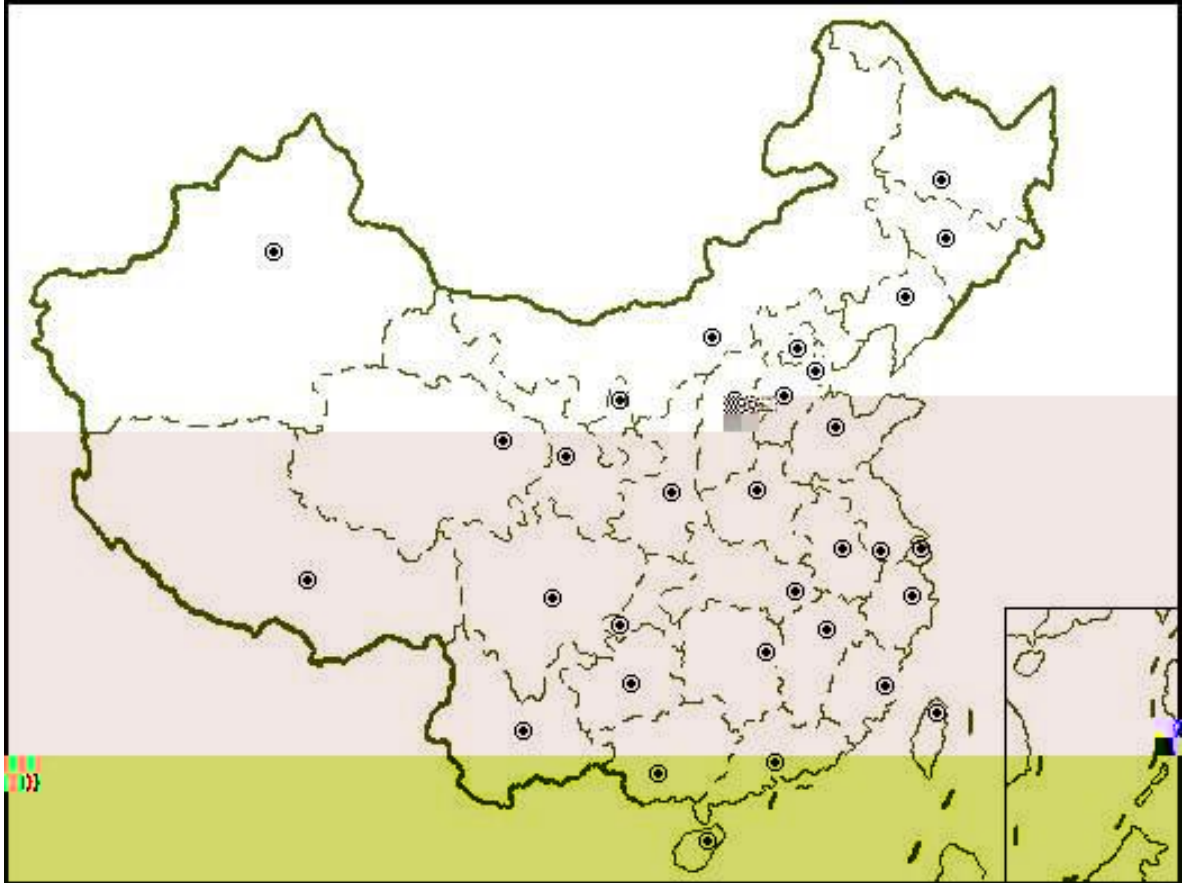

2

3-5

Word

2

| | | |
|--|---|----|
| | | |
| | 2 | 30 |

| | | | | |
|--|----|----|----|--------|
| | 1 | 30 | 40 | Office |
| | 5 | | | |
| | | 30 | | |
| | 30 | 2 | | |

3

60

4

| | | | | |
|-------|----|-----|---|---|
| | | | | |
| (20) | 5 | | 5 | |
| | 5 | | 1 | |
| | 10 | | 4 | |
| (80) | | | 5 | 0 |
| | 20 | | 5 | |
| | 10 | | 1 | 2 |
| | 20 | | 1 | 5 |
| | 10 | 3-5 | 1 | 5 |
| | 20 | | 1 | 5 |

7.

2-7

1

1

1000

10

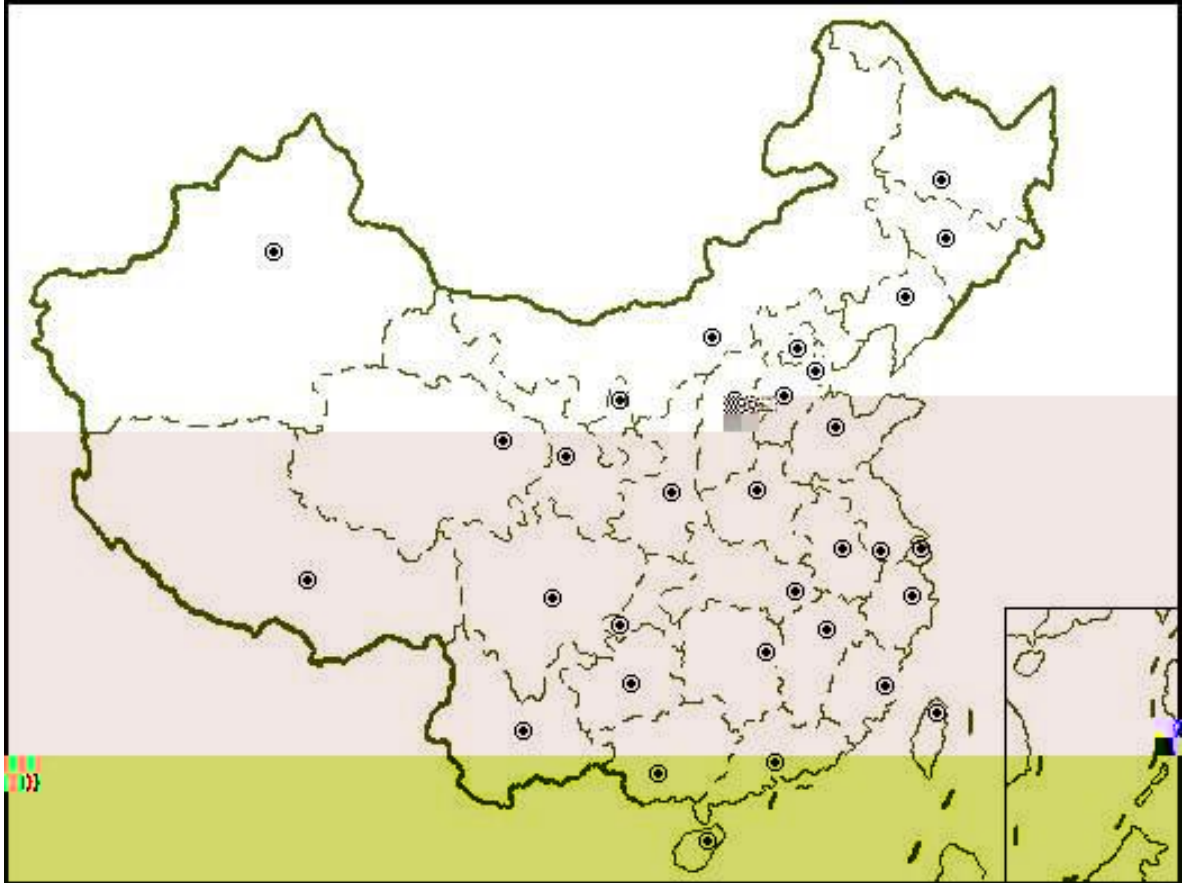

2

3-5

Word

2

| | | |
|--|---|----|
| | | |
| | 2 | 30 |

| | | | | |
|--|----|----|----|--------|
| | 1 | 30 | 40 | Office |
| | 5 | | | |
| | | 30 | | |
| | 30 | 2 | | |

3

60

4

5

(20)

| | | | | |
|--|----|----|----|--------|
| | 1 | 30 | 40 | Office |
| | 5 | | | |
| | | 30 | | |
| | 30 | 2 | | |

3

60

4

| | | | | |
|-------|----|-----|---|---|
| | | | | |
| (20) | 5 | | 5 | |
| | 5 | | 1 | |
| | 10 | | 4 | |
| (80) | | | 5 | 0 |
| | 20 | | 5 | 5 |
| | 10 | | 1 | 2 |
| | 10 | | 1 | 5 |
| | 20 | 3-5 | 1 | 5 |
| | | | 1 | 5 |
| | 20 | | 1 | 5 |

9.

2-9

1

1

20

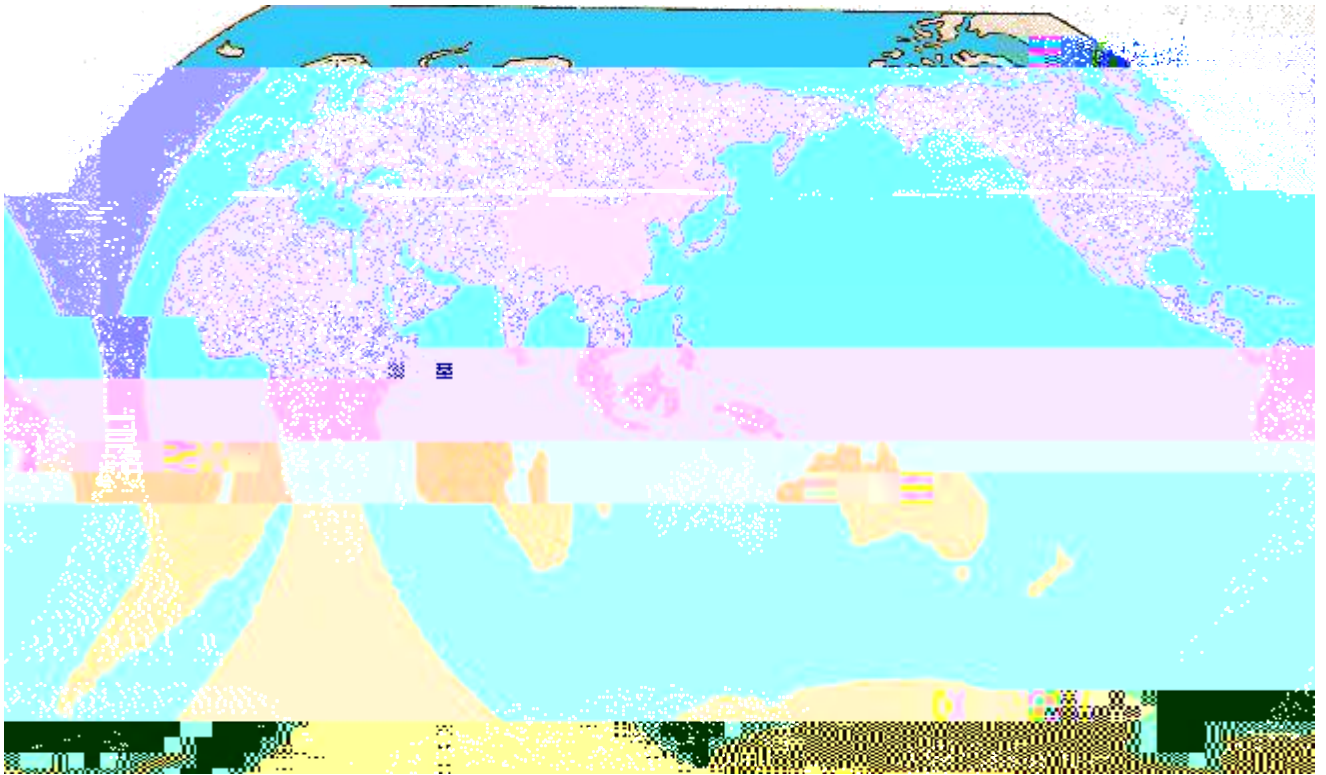

2

3-5

400

Word

2

| | | |
|--|--|--|
| | | |
|--|--|--|

| | | | |
|--------|----|-------|--|
| | 2 | 30 | |
| | 1 | 30 40 | |
| Office | 5 | | |
| | 30 | | |
| | 30 | 2 | |

3

60

4

| | | | | |
|-------|----|-----|----------|---|
| | | | | |
| (20) | 5 | | 5 | 0 |
| | 5 | | 1 | |
| | 10 | | 4 | |
| | | 5 | | |
| | | 5 | | |
| (80) | 20 | | 5 | |
| | 20 | | 1 2 | |
| | 10 | | 1 2 | |
| | 10 | 3-5 | 1 2 3 | |
| | | 1 2 | | |
| | 20 | | 1 5 | |

10.

2-10

1

1

3000

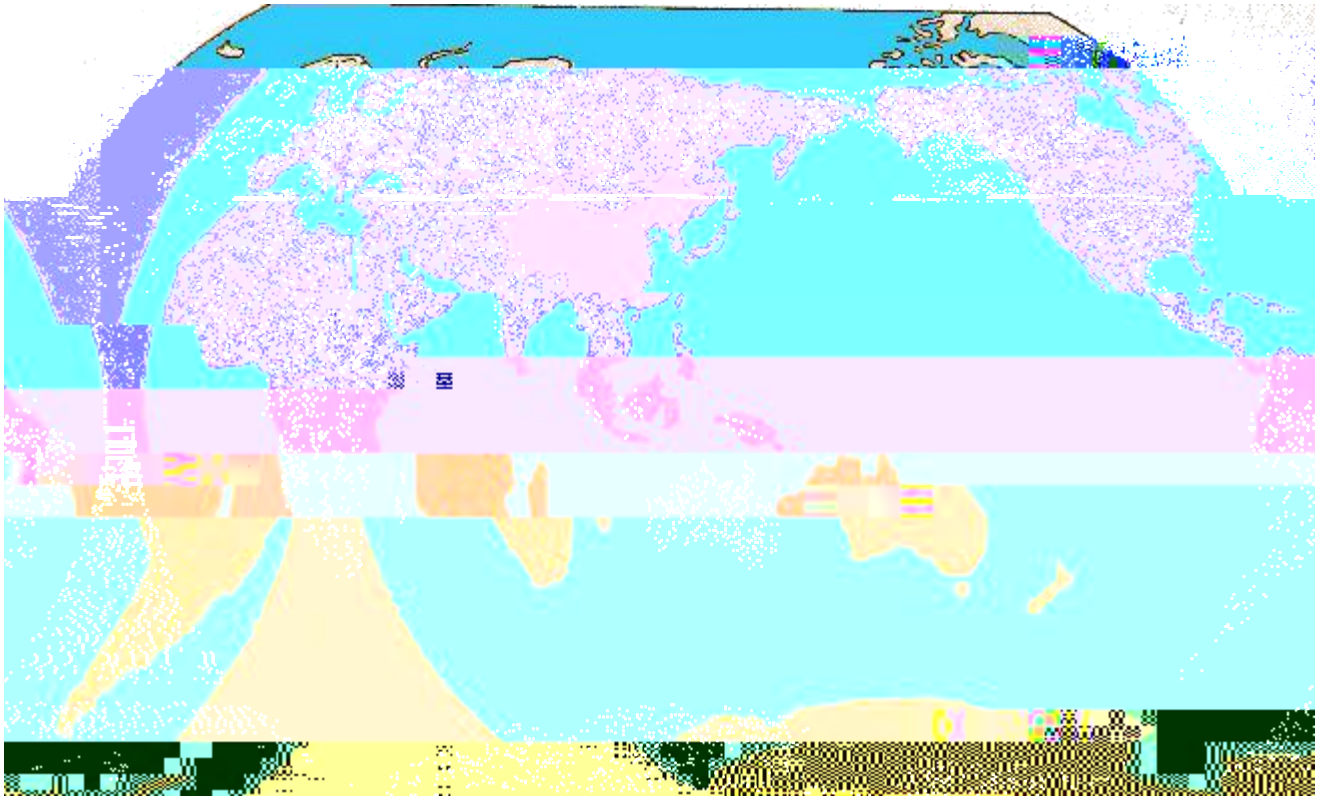

2

3-5

Wörd

2

| | | |
|--|--|--|
| | | |
|--|--|--|

| | | | |
|--|----|-------|--------|
| | 2 | 30 | |
| | 1 | 30 40 | Office |
| | 5 | | |
| | | 30 | |
| | 30 | 2 | |

3

60

4

| | | | | |
|-------|----|-----|-------------|---|
| | | | | |
| (20) | 5 | | 5 | 0 |
| | 5 | | 1 | |
| | 10 | | 4 5 5 | |
| (80) | 20 | | 5 5 | |
| | 20 | | 1 2 | |
| | 10 | | 1 2 | |
| | 10 | 3-5 | 1 2 3 | |
| | 20 | | 1 2 1 5 | |

2-11

1

1

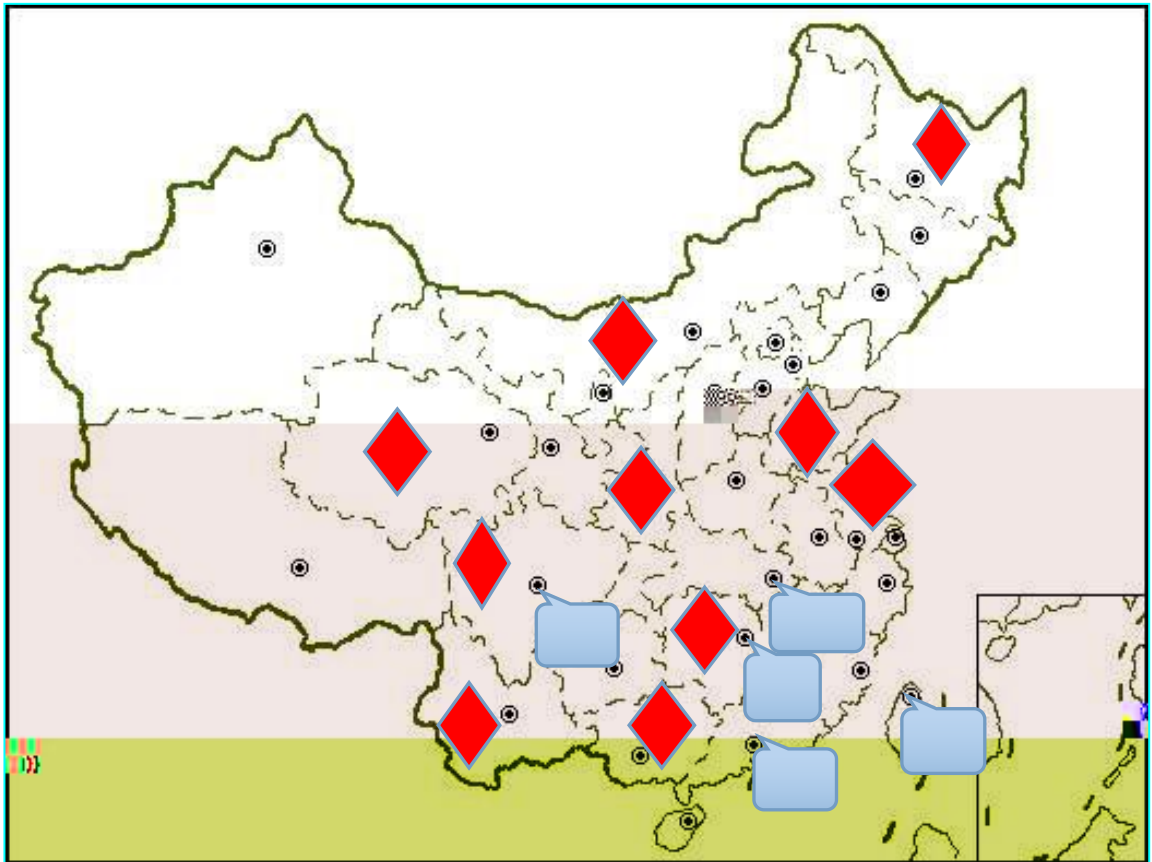

2

5

Word

2

| | | |
|--|----|-----------------|
| | | |
| | 2 | 30 |
| | 1 | 30 40 Office |
| | 5 | |
| | 30 | |
| | 30 | 2 |

3

60

4

| | | | | |
|-------|----|--|------------|---|
| | | | | |
| (20) | 5 | | 5 | 0 |
| | 5 | | 1 4 | |
| | 10 | | 5 5 | |
| (80) | 20 | | 1 2 1 2 | |
| | 20 | | 1 4 1 4 | |
| | 40 | | 1 4 1 4 | |

12

2-12

1

1



2

G5513

Word

2

| | | |
|--|----|-----------------|
| | | |
| | 2 | 30 |
| | 1 | 30 40 Office |
| | 5 | |
| | 30 | |
| | 30 | 2 |

3

60

4

| | | | | |
|-------|----|-----|--------------|-------|
| | | | | |
| (20) | 5 | | 5 | 0 |
| | 5 | | 1 4 | |
| | 10 | | 5 5 | |
| (80) | 20 | | 1 2 1 2 | J1-32 |
| | 20 | | 1 2 1 2 | |
| | 20 | 3-5 | 1 2 3 1 2 | |
| | 20 | | 1 5 | |

13.

2-13

1

1)

17.5

2

Word

2

| | | |
|--|----|-----------------|
| | | |
| | 2 | 30 |
| | 1 | 30 40 Office |
| | 5 | |
| | 30 | |
| | 30 | 2 |

3

60

4

| | | | |
|-------|----|--|--------|
| | | | |
| (20) | 5 | | 5 |
| | 5 | | 1 4 |
| | 10 | | 5 5 |

| | | | | | |
|-------|--|----|--|--------------|---|
| | | | | | 0 |
| (80) | | 30 | | 1 10 1 10 | |
| | | 30 | | 1 10 1 10 | |
| | | 20 | | 1 5 | |

14. 2-14

1

1

30

400

Word

2

| | | | |
|--|----|-------|--------|
| | | | |
| | 2 | 30 | |
| | 1 | 30 40 | Office |
| | 5 | | |
| | 30 | | |
| | 30 | 2 | |

3

60

4

| | | | | |
|--|--|--|--|--|
| | | | | |
|--|--|--|--|--|

5

5

5

(20)

0

Word

2

| | | |
|--|----|-----------------|
| | | |
| | 2 | 30 |
| | 1 | 30 40 Office |
| | 5 | |
| | 30 | |
| | 30 | 2 |

3

60

4

| | | | | |
|-------|----|--|------------|---|
| | | | | |
| (20) | 5 | | 5 | 0 |
| | 5 | | 1 4 | |
| | 10 | | 5 5 | |
| (80) | 30 | | 1 5 1 5 | |
| | 30 | | 1 5 1 5 | |
| | 20 | | 5 | |

1.

3-1

1

1

4538kg

RMB145

RMB1.2/t•km

100

88
360km

100

2

20

10

20

| | | | | | | |
|---|---|---|---|---|---|---|
| | | | | | | |
| | | | | | | |
| | | | | | | |
| * | * | * | * | * | * | * |
| | | | | | | |
| | | | | | | |
| | | | | | | |
| | | | | * | | |
| | | | | | | |
| | | | | | | |

| | | |
|--|--|--|
| | | |
|--|--|--|

"

"

10000

4‰

6000

15

15

2

| | | |
|--|--------|---------|
| | | |
| | 2 | 30 |
| | | 1 30 40 |
| | Office | 5 |
| | | 30 |
| | 30 | 2 |

3

60

4

2

100

20%

80%

1

1

| | | | |
|--|---|--|---|
| | | | |
| | 5 | | 5 |

| | | | | | | |
|-------|--|----|--|----|---|--------|
| (20) | | 5 | | 1 | 0 | |
| | | | | 4 | | |
| | | 10 | | 5 | | |
| | | | | 5 | | |
| (80) | | 20 | | 15 | | 5 |
| | | 15 | | 10 | | 5 |
| | | 10 | | | | 5 5 |
| | | 15 | | | | 8 7 |
| | | 20 | | 1 | | |

2

3-2

1

1

25

5123kg

1.2 /t. km

330km

165 (

100

100

333)

$s \geq 300$

$w \leq 2$ 98%

$2 \leq w \leq 4$ 96%

$4 \leq w \leq 6$ 94%

$w \geq 6$ 92%

$s < 300$

$w \leq 2$ 100%

2<=W<4 98%

4<=W<6 96%

W=6 94%

2)

20

10

"

"

5000

4‰

300000

"

"

15

20

| | | | | | | | | | |
|--|--------------------------|--------------------------|--|--------------------------|--------------------------|--------------------------|--------------------------|--------------------------|--------------------------|
| | | | | | | | | | |
| | | | | | | | | | |
| | | | | | | | | | |
| | | | | | | | | | |
| | | | | | | | | | |
| | <input type="checkbox"/> | <input type="checkbox"/> | | <input type="checkbox"/> | <input type="checkbox"/> | | | | |
| | <input type="checkbox"/> | <input type="checkbox"/> | | | | | | | |
| | | | | | | <input type="checkbox"/> | <input type="checkbox"/> | <input type="checkbox"/> | <input type="checkbox"/> |
| | | | | | | | | | |
| | | | | | | | | | |

| | | |
|--|--------|-------|
| | | |
| | 2 | 30 |
| | 1 | 30 40 |
| | Office | 5 |
| | | 30 |
| | 30 | 2 |

3

60

4

2

100

20%

80%

1

1

| | | | | |
|-------|----|--|--------|---|
| | | | | |
| (20) | 5 | | 5 | 0 |
| | 5 | | 1 | |
| | 10 | | 4 5 | |
| (80) | 20 | | 5 | |
| | 15 | | 15 | |
| | 20 | | 1 | |
| | 15 | | 15 | |
| | 10 | | 10 | |

3

3-3

1

1

2010 8 12

500

160ml

15kg

500

0.4 /

1‰

2010 8 15

2010 8 16

2

10

20

15

| | | | | | | |
|---|---|---|---|---|---|---|
| | | | | | | |
| | | | | | | |
| | | | | | | |
| * | * | * | * | * | * | * |
| | | | | | | |
| | | | | | | |
| | | | | | | |
| * | | * | | * | | |
| | | | | | | |
| | | | | | | |
| | | | | | | |

| | | |
|--|--|--|
| | | |
|--|--|--|

15

20

2

| | | |
|--|--------|---------|
| | | |
| | 2 | 30 |
| | | 1 30 40 |
| | Office | 5 |
| | | 30 |
| | 30 | 2 |

3

60

4

2

100

20%

80%

1

1

| | | | |
|-------|----|--|--------|
| | | | |
| (20) | 5 | | 5 |
| | 5 | | 1 |
| | 10 | | 4 5 |

| | | | | | |
|--|--|--|--|--------|------|
| | | | | 5 | |
| | | | | 4 8 | |
| | | | | 1920 / | |
| | | | | 923 | |
| | | | | 48 / | |
| | | | | | 2000 |
| | | | | | 320 |
| | | | | | 2000 |
| | | | | | 500 |
| | | | | | 800 |
| | | | | | 200 |
| | | | | | |
| | | | | | |
| | | | | 1000 | |
| | | | | 8 | |

15

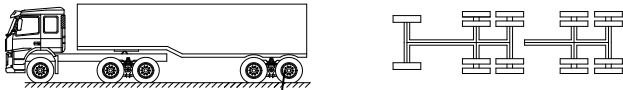
| | | | | |
|-------------------------------------------------------------------------------------|--|--|--|--|
| | | | | |
|  | | | | |
|  | | | | |

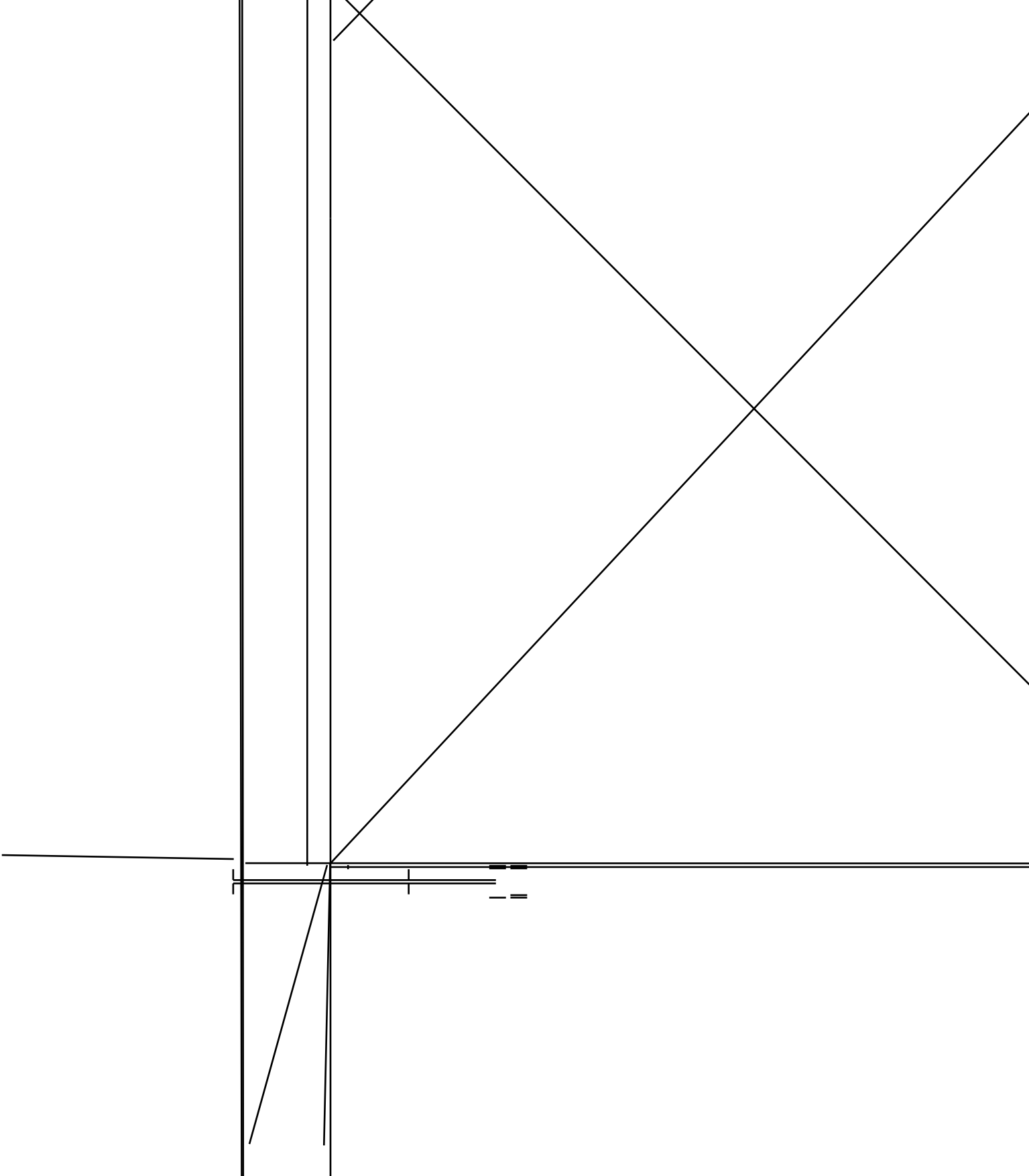
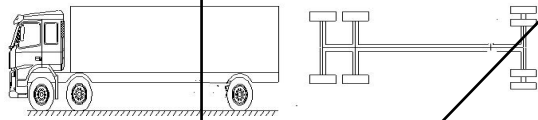

| | | | | |
|-------|----|--|-----------------|---|
| (20) | 5 | | 1 | 0 |
| | 10 | | 4 5 5 | |
| | 15 | | 5 10 | |
| | 20 | | 1.5 2 2.5 | |
| | 15 | | 3 | |
| | 15 | | 15 | |
| | 15 | | 15 | |

5. 3-5

1

1

QH1011100012

95

| | | |
|--|--|----|
| | | |
| | | 35 |
| | | 20 |
| | | 20 |

KS1011150008

64

| | | |
|--|--|--|
| | | |
|--|--|--|



1

| | | |
|--|--|----|
| | | 35 |
| | | 20 |
| | | 10 |

DD1011150012

102

| | | |
|--|--|----|
| | | |
| | | 30 |
| | | 35 |
| | | 30 |

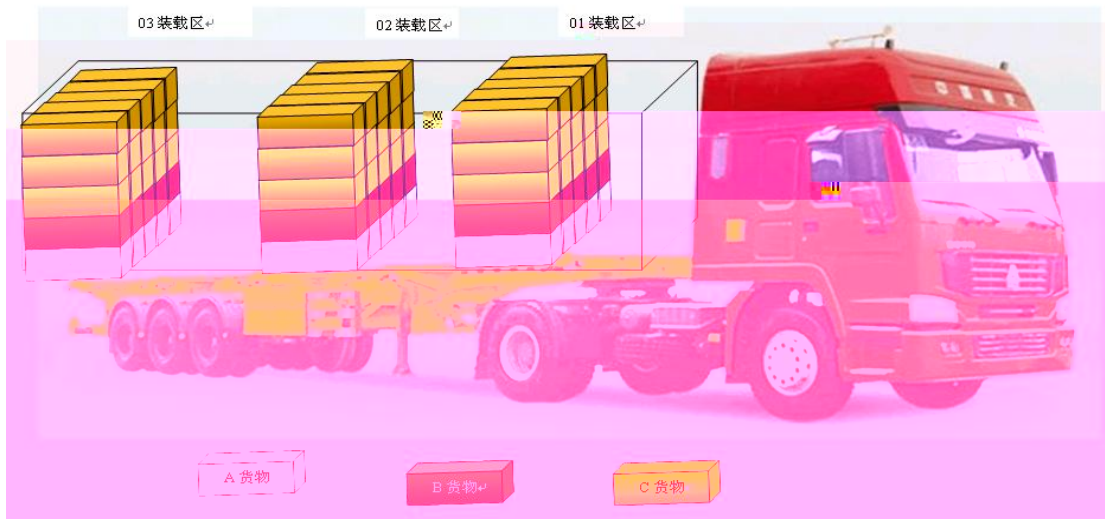

2)

01

02

03

A

B

C

20

A B

A

20

0.03m³

B

10

0.02m³

10

10

2

| | | |
|--|----------|-------|
| | | |
| | 2 | 30 |
| | 1 | 30 40 |
| | Office 5 | |
| | 30 | |
| | 30 | 2 |

3

60

4

2

100

20%

80%

1



1

| | | | | |
|-------|----|--|-------------|---|
| | | | | |
| (20) | 5 | | 5 | 0 |
| | 5 | | 1 | |
| | 10 | | 4 5 5 | |
| (80) | 20 | | 10 10 | 5 |
| | 20 | | 15 | |

| | | | | | | | | | |
|--|--------------------------|--------------------------|--|--|--------------------------|--------------------------|--------------------------|--------------------------|--------------------------|
| | | | | | | | | | |
| | | | | | | | | | |
| | <input type="checkbox"/> | <input type="checkbox"/> | | | <input type="checkbox"/> | <input type="checkbox"/> | | | |
| | <input type="checkbox"/> | <input type="checkbox"/> | | | | | | | |
| | | | | | | | <input type="checkbox"/> | <input type="checkbox"/> | <input type="checkbox"/> |
| | | | | | | | | | |
| | | | | | | | | | |

D

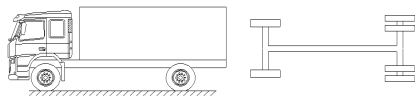
15

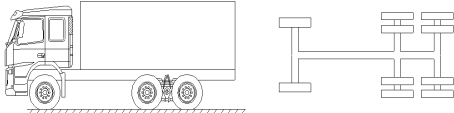
| | | | |
|-------------------------------------------------------------------------------------|--|--|--|
| | | | |
|  | | | |
|  | | | |
|  | | | |

10

2

| | | | |
|--|----|--------|--|
| | | | |
| | 2 | 30 | |
| | 1 | 30 40 | |
| | 5 | Office | |
| | 30 | | |

| | | | |
|--|----|---|--|
| | 30 | 2 | |
|--|----|---|--|

3

60

4

2

100

20%

80%

1

| | | | | |
|-------|----|--|---------|---|
| | | | | |
| (20) | 5 | | 5 | 0 |
| | 5 | | 1 4 | |
| | 10 | | 5 5 | |
| (80) | 15 | | 10 5 | |
| | 20 | | 15 5 | |
| | 20 | | 2 | |
| | 15 | | 2 15 | |
| | 10 | | 5 5 | |

7. 3-7

1

1

T

" " "

"

1/3

" " "

" " "

2)

15

10

| | | | |
|--|--|--|--|
| | | | |
| | | | |
| | | | |
| | | | |

T

15

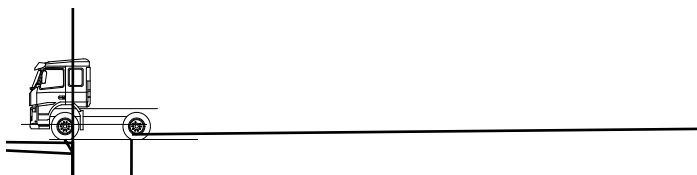
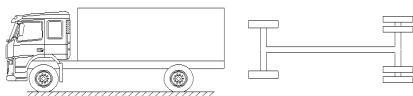

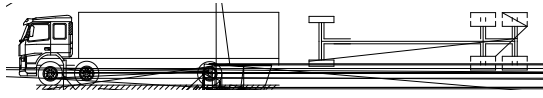

| | | | | |
|-------|----|--|-----------|---|
| (20) | 5 | | 5 | 0 |
| | 5 | | 1 4 | |
| | 10 | | 5 5 | |
| (80) | 15 | | 10 5 | |
| | 15 | | 2 15 | |
| | 20 | | 10 10 | |
| | 20 | | 15 5 | |
| | 10 | | 1.5 10 | |

8. 3-8

(1)

1

2010 11 6 10:00

SYTKH015

YD201010170004

10

0535- 6799811

89

0531- 86429521

100A45

40× 20× 15cm

1. 5kg

200

2. 4M

100B37

35× 25

× 10cm

1. 8kg

150

1. 3M

100C64

18× 26× 8cm

1kg

100

0. 4M

100D87

41× 22× 20 cm

1. 8kg

100

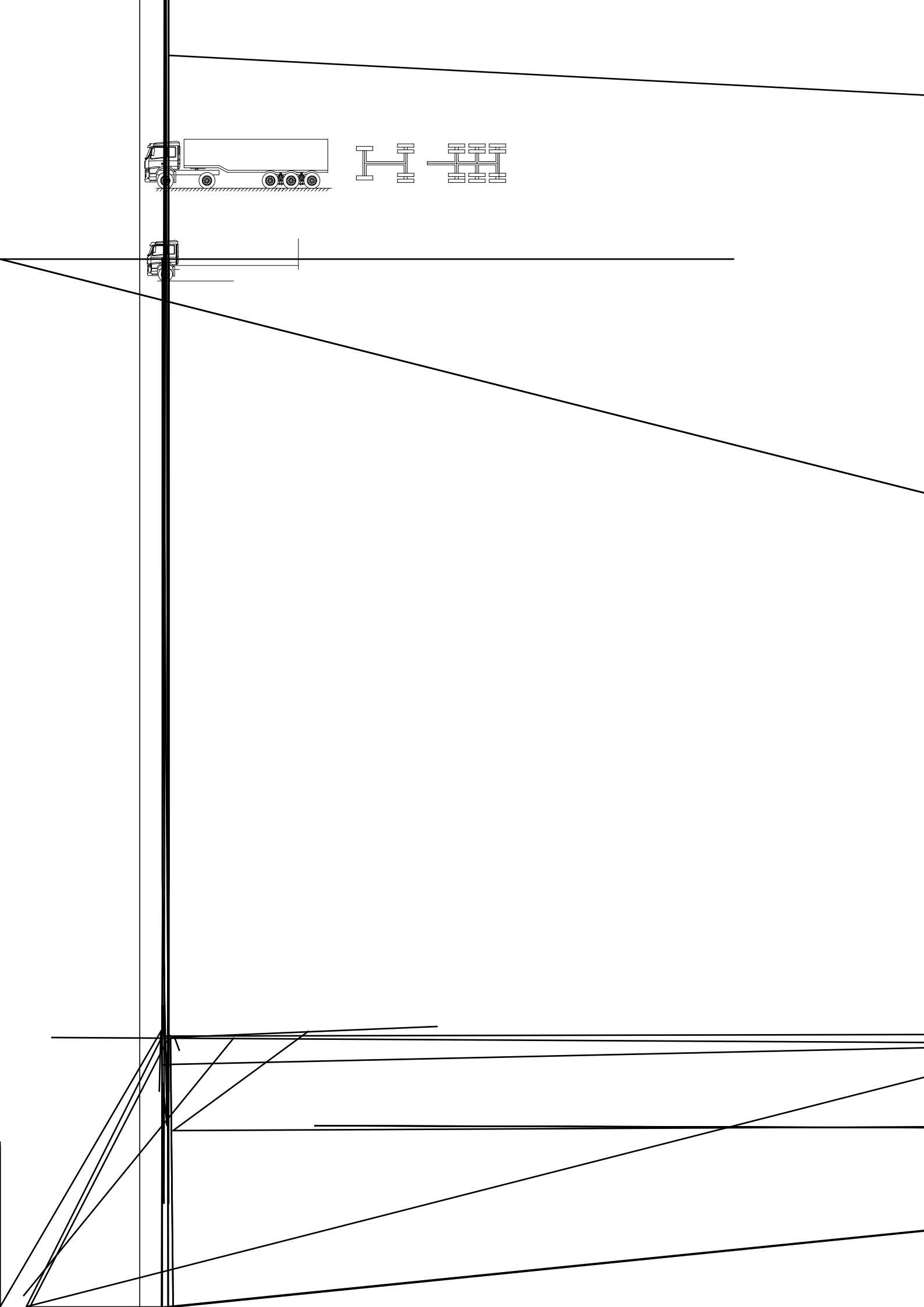
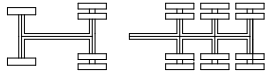
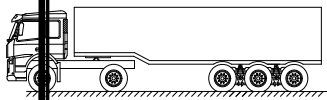

| | | | | |
|-------|----|--|--------|---|
| (20) | 5 | | 5 | 0 |
| | 5 | | 1 4 | |
| | 10 | | 5 5 | |
| (80) | 20 | | 1 | |
| | 20 | | 1 | |
| | 15 | | 15 | |
| | 15 | | 2 | |
| | 10 | | 10 | |

9.

3-9

1

1

35

40000

7200

32000

2000

300 /

10

300 / × 35 × 6

3 6

=63000

5000

3000

3000

2

2100

600

105

374

726

2)

20

43.2

5

3

6

3000 /

374+726

105 /

5000

2100

3000

600

| | | |
|--|--------|-------|
| | | |
| | 2 | 30 |
| | 1 | 30 40 |
| | Office | 5 |
| | | 30 |
| | 30 | 2 |

3

60

4

2

100

20%

80%

1

1

| | | | | |
|-------|----|--|-------------|---|
| | | | | |
| (20) | 5 | | 5 | 0 |
| | 5 | | 1 | |
| | | | 4 | |
| (80) | 10 | | 5 | |
| | | | 5 | |
| | 20 | | 1.5 , 2 2.5 | |
| | 15 | | 15 | |

| | | | | | |
|--|--|----|--|----|---|
| | | | | | |
| | | 15 | | 2 | |
| | | 15 | | 10 | 5 |
| | | 15 | | 10 | 5 |

10.

3-10

1

1

20t B6

1 9.2 /t 2

0.0506 / t km

2962km B6 38

30%

2)

20

15

10

20

15

2

| | | |
|--|---|-------|
| | | |
| | 2 | 30 |
| | 1 | 30 40 |

| | | | |
|--|--------|----|--|
| | Office | 5 | |
| | | 30 | |
| | 30 | 2 | |

3

60

4

2

100

20%

80%

1

1

| | | | | |
|-------|--|----|--|----|
| | | | | |
| (20) | | 5 | | 5 |
| | | 5 | | 1 |
| | | 10 | | 4 |
| (80) | | 20 | | 5 |
| | | 15 | | 15 |
| | | 10 | | 5 |
| | | | | 0 |

| | | | | | |
|--|--|----|--|----|--------|
| | | 15 | | 10 | 5 |
| | | 20 | | | 8 2 |

11.

3-11

1

1

26t 60t
556km 6 6
1 14.6 /t 2 0.0704 / t km

2)

20

15

10

15

20

2

| | | |
|--|--------|-------|
| | | |
| | 2 | 30 |
| | 1 | 30 40 |
| | Office | 5 |
| | | 30 |
| | 30 | 2 |

3

60

4
20% 2 80% 100
1
1

12

3-12

1

1

HF

GUANGZHOU HF Trading CO., LTD.
 Room 502, No. 838, Dongfeng Road, Guangzhou, Chi na
 TEL: 020-87656751 FAX: 020-87656772

AL QADAH TRADING COMPANY L. L. C
 202 W 1st St. LOS ANGELES, CA 90012
 Phone (877) 554-4000 Fax (213) 237-3535

PRODUCT: CLEANING BALL
 PARTIAL SHIPMENT allowed
 TRANSSHIPMENT : allowed

| | | | | | | |
|--|--|--|--|--|--|--|
| | | | | | | |
| | | | | | | |

TIME OF SHIPMENT() 2016 5 15
 SERVICE TYPE() CY/CY
 FREIGHT() PREPAID
 PORT OF LOADING() SHENZHEN
 PORT OF DISCHARGE() LOS ANGELES

USD1450/20GP, USD1800/40GP, USD1800/40HQ

| | | |
|--|--|--|
| | | |
|--|--|--|

COSCO CONTAINER LINES

| 干货箱 | | | | | | | | |
|-------------------------------------------------------------------------------------|--------|-------|------|-----------|-------|--------------|------|------|
|  | 箱体内部尺寸 | | | 箱体内容积及载重量 | | 箱门开度尺寸 | | |
| | L | W | H | Cu | P | W | H | |
| | 20' | 5898 | 2352 | 2393 | 33.2 | 21740/28230# | 2340 | 2280 |
| | 40' | 12032 | 2352 | 2393 | 67.7 | 26630 | 2340 | 2280 |
| HC | 12032 | 2352 | 2698 | 76.3 | 26520 | 2340 | 2585 | |
| 冷藏箱 | | | | | | | | |
|  | 箱体内部尺寸 | | | 箱体内容积及载重量 | | | | |
| | L | W | H | Cu | P | | | |
| | 20' | 5444 | 2284 | 2267 | 28.5 | 21135/27160# | | |
| | 40' | 11583 | 2284 | 2250 | 58.7 | 26580 | | |
| HC | 11583 | 2286 | 2556 | 67.9 | 26380 | | | |
| 开顶箱 | | | | | | | | |
|  | 箱体内部尺寸 | | | 箱体内容积及载重量 | | | | |
| | L | W | P | Cu | P | | | |
| | 20' | 5900 | 2330 | 2337 | 32.6 | 21740 | | |
| | 40' | 12025 | 2330 | 2337 | 65.8 | 26410 | | |

2

| | | |
|----|----|--------|
| | | |
| | 2 | 30 |
| | 1 | 30 40 |
| 5 | | Office |
| | 30 | |
| 30 | 2 | |

| | | |
|--|--|--|
| | | |
|--|--|--|

3

60

4

2

100

20%

80%

1

| | | | | |
|--|--|--|---|---|
| | | | | |
| | | | | |
| | | | | |
| | | | | |
| | | | | 1 |
| | | | | |
| | | | | |
| | | | | |
| | | | | |
| | | | " | " |

13.

HD

?

200 37% WMO 10 28% 25% 1m3

HOUSE B/L MASTER B/L HOUSE B/L,

2

| | | |
|--|----|-----------------|
| | | |
| | 2 | 30 |
| | 1 | 30 40 Ofi ce |
| | 5 | |
| | 30 | |
| | 30 | 2 |

3

60

4

20% 2 100 80%

1

7

3

4

U

HOUSE B/L MASTER B/L

14. 3-14

1

1

LX

DO

(computer parts)

2014 10 7 20 00

60X50X40CM

10kg/

16000 /

5

| PEK | | | | LAX | | |
|-----|--|--|--|-----|--|--|
| | | | | | | |
| | | | | | | |

2)

| | | | | | |
|--|--|--------------------------|--------------------------|--------------------------|--------------------------|
| | | | | | |
| | | | | | |
| | | | | | |
| | | <input type="checkbox"/> | <input type="checkbox"/> | <input type="checkbox"/> | <input type="checkbox"/> |
| | | | | | |
| | | | | | |

| | | | | |
|--------------------------|--------------------------|--|--|--|
| | | | | |
| | | | | |
| <input type="checkbox"/> | <input type="checkbox"/> | | | |
| <input type="checkbox"/> | <input type="checkbox"/> | | | |
| | | | | |
| | | | | |

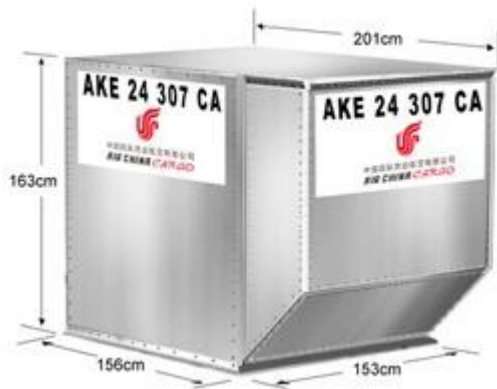

2

| | | |
|--|---|-------|
| | | |
| | 2 | 30 |
| | 1 | 30 60 |

| | | |
|-----------------------------------------------------------------------------------|----|--------|
| | 5 | Office |
| | | 30 |
|  | 30 | 2 |

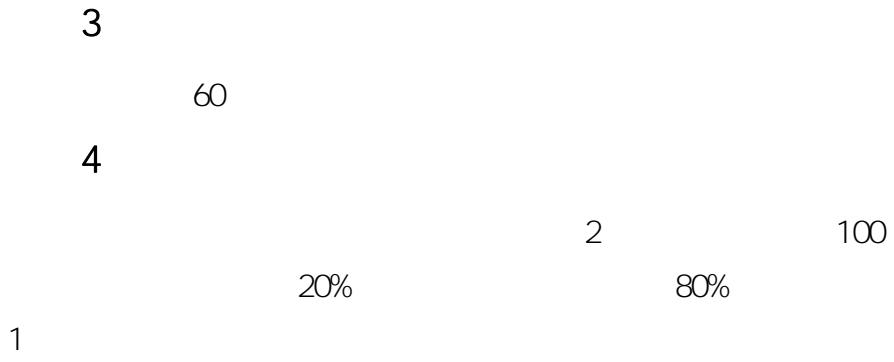

2

0

| | | | | | |
|--|--|--|--|--|--|
| | | | | | |
| | | | | | |

15.

3-15

1

1

Taps

35.6

| | | | |
|---------------|-----|----|-------|
| BEI JI NG | CN | | BJS |
| Y. RENMI NGBI | CNY | | KGS |
| SI NGAPORE | SN | M | 200 |
| | | N | 30.5 |
| | | 45 | 22.49 |

6000 cm³ /kg ,

0.5

2)

| | | | | | |
|--|--|--|--|--|--|
| | | | | | |
|--|--|--|--|--|--|

| | | | | | | | |
|--|--|--|--|--|--|--|--|
| | | | | | | | |
| | | | | | | | |

2

| | | | | | |
|--|--|----|----|----|--------|
| | | | | | |
| | | 2 | | 30 | |
| | | | 1 | 30 | 60 |
| | | 5 | | | Office |
| | | | 30 | | |
| | | 30 | 2 | | |

3

60

4

2

100

20%

80%

1

| | | | | |
|--|--|--|--|--|
| | | | | |
| | | | | |
| | | | | |
| | | | | |

| | | | | | |
|--|--|--|--|----|--|
| | | | | | |
| | | | | 10 | |
| | | | | 5 | |
| | | | | | |
| | | | | | |
| | | | | 2 | |
| | | | | | |

1. 4-1

1

() 20

50

40

1

()

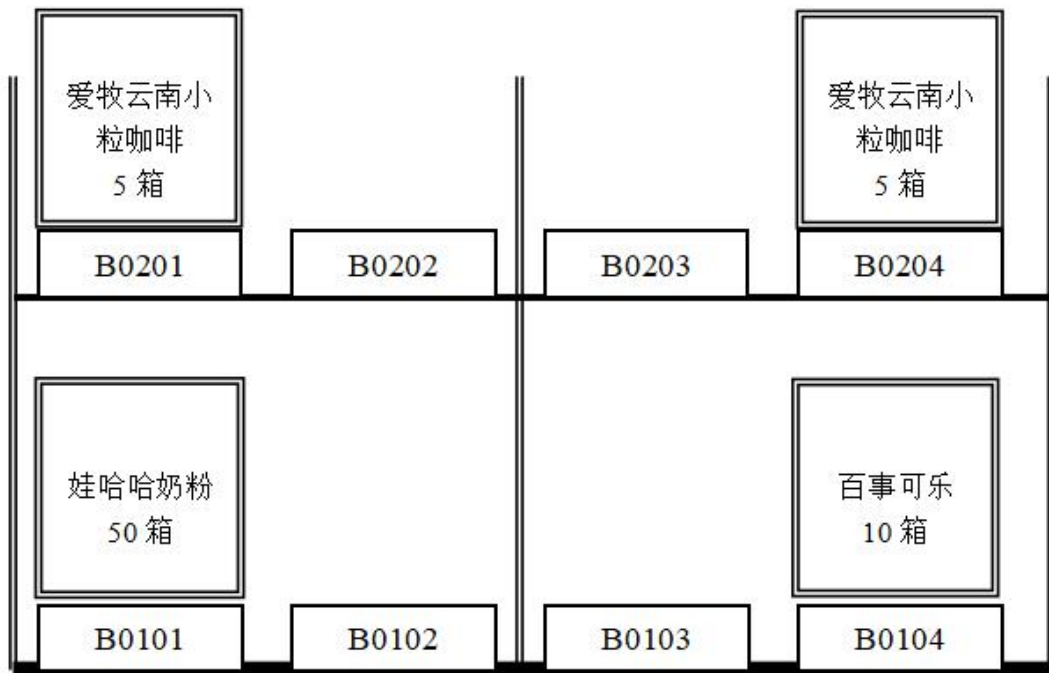

| | | | | | | | |
|---|-----|--|--|--|--|--|--|
| | | | | | | | |
| 1 | | | | | | | |
| 2 | () | | | | | | |
| | | | | | | | |
| | | | | | | | |

- ①
- ②
- ③
- ④
- ⑤
- ⑥
- ⑦
- ⑧

RF

RF

RF

RF

2

| | | | | | | | |
|--|-------|-------|--------|---|----|---|---|
| | | | | | | | |
| | 2 | 2 | 2×2 | | 1 | | 1 |
| | | | 2 | | 1 | 1 | 1 |
| | | 1 | | 1 | RF | | 2 |
| | 2 | | 1 | | 1 | | |
| | 1200× | 1000× | 144 mm | | 10 | | |

| | | |
|--|--|--|
| | | |
|--|--|--|

3

60

4

| | | | | — |
|--|--|--|--|----|
| | | | | — |
| | | | | — |
| | | | | — |
| | | | | |
| | | | | |
| | | | | |
| | | | | |
| | | | | -5 |
| | | | | |
| | | | | |
| | | | | -5 |
| | | | | |
| | | | | -5 |
| | | | | — |
| | | | | |
| | | | | |

2

4-2

1

40

40

20

1

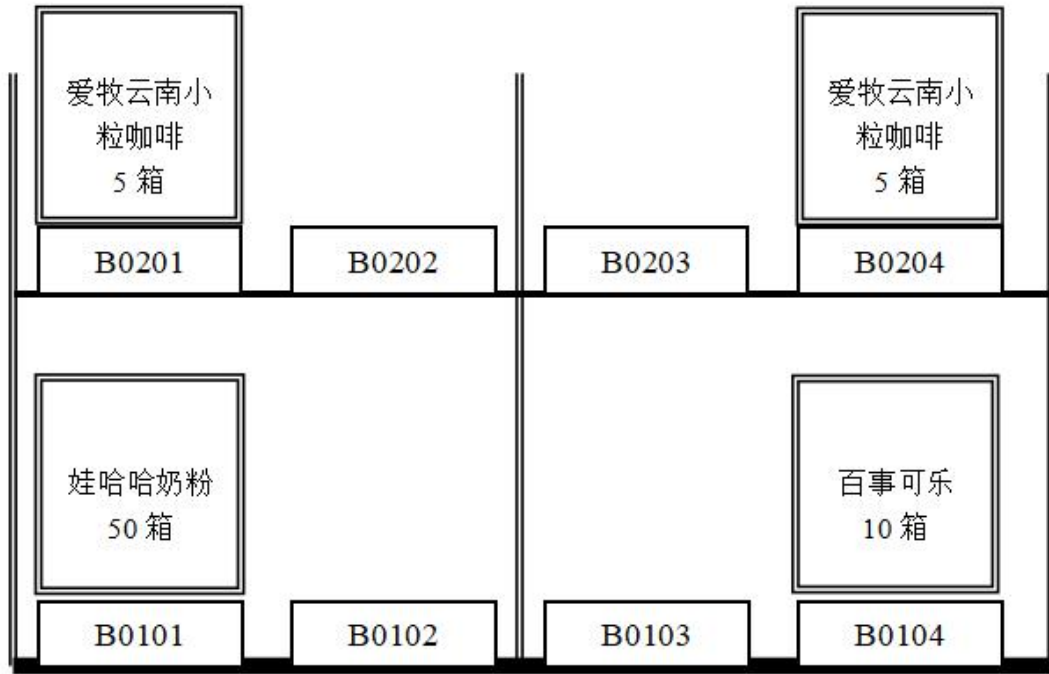
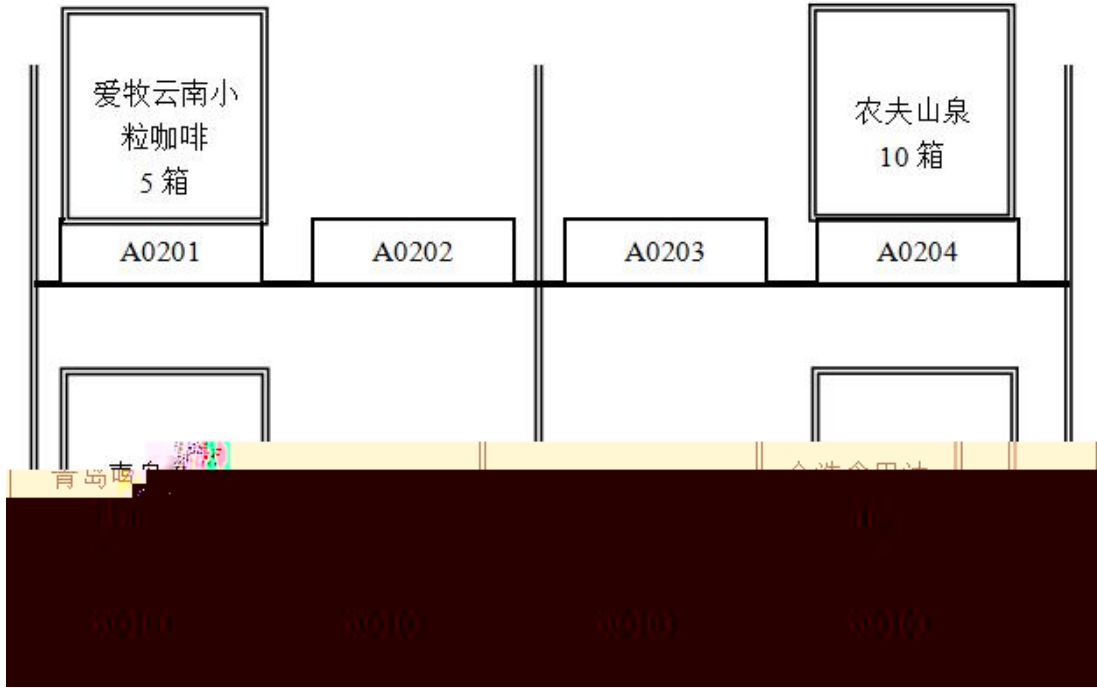

| 1 | | | 40 | | | | |
|---|--|--|----|-------|--|--|--|
| 2 | | | | 330ml | | | |
| | | | | 330ml | | | |
| | | | | | | | |

RF

RF

RF

RF

2

| | 2 2 2× 2 2 1 1 1 1 1 RF 2 2 1 1 | |
|--|--------------------------------------------------------------------------------------------------------------------------------|--|
| | 1200× 1000× 144 mm 10 | |

| | | |
|--|--|--|
| | | |
|--|--|--|

3

60

4

| | | | — | |
|--|--|---|----|--|
| | | | — | |
| | | | — | |
| | | | — | |
| | | | | |
| | | | | |
| | | | | |
| | | | | |
| | | | | |
| | | | -5 | |
| | | | | |
| | | | -5 | |
| | | | | |
| | | | -5 | |
| | | — | | |
| | | | | |
| | | | | |

3.

4-3

1

20

40

30

1

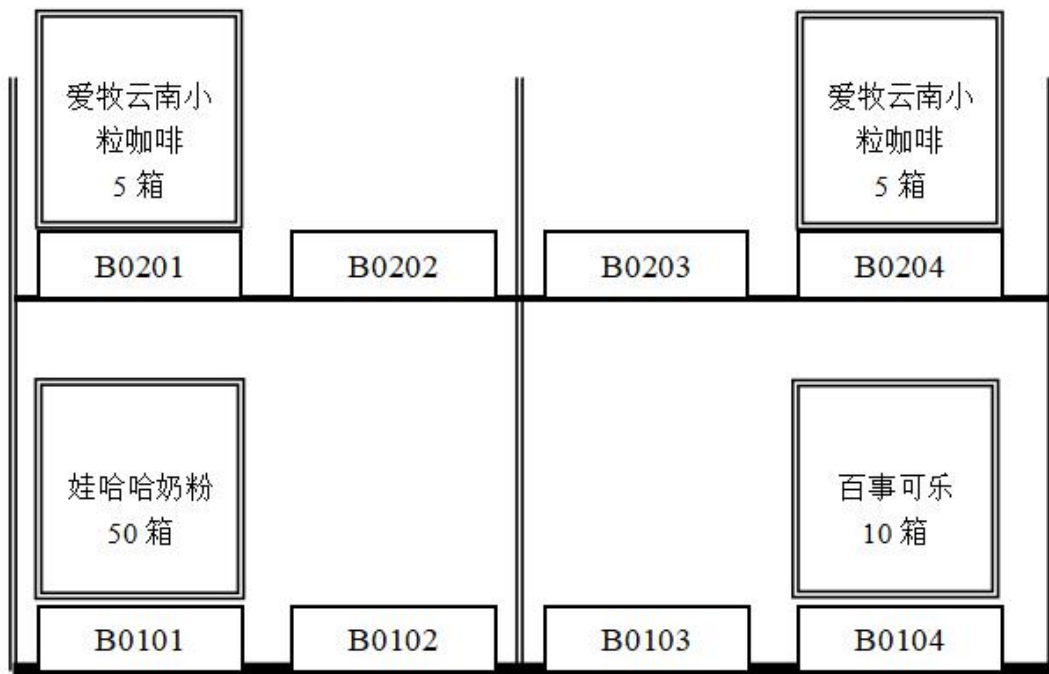

| | | |
|--|--|--|
| | | |
|--|--|--|

3

60

4

| | | | — |
|--|--|--|----|
| | | | — |
| | | | — |
| | | | — |
| | | | |
| | | | |
| | | | |
| | | | |
| | | | |
| | | | -5 |
| | | | |
| | | | |
| | | | -5 |
| | | | |
| | | | |
| | | | -5 |
| | | | — |
| | | | |
| | | | |

4.

4-4

1

40

30

30



| | | |
|--|--|--|
| | | |
|--|--|--|

3

60

4

| | | | | — |
|--|--|---|----|----|
| | | | | — |
| | | | | — |
| | | | | — |
| | | | | |
| | | | | |
| | | | | |
| | | | | |
| | | | | |
| | | | | |
| | | | -5 | |
| | | | | |
| | | | | |
| | | | -5 | |
| | | | | |
| | | | | -5 |
| | | — | | |
| | | | | |
| | | | | |

5.

4-5

1

40

40

20

1



| 1 | () | | | | | | |
|---|-----|--|--|--|--|--|--|
| 2 | | | | | | | |
| | | | | | | | |
| | | | | | | | |

RF

RF

RF

RF

2

| | 2 | 2 | 2x 2 | | | 1 | | 1 | |
|--|---|---|------|---|---|----|---|---|--|
| | | | 2 | | 1 | | 1 | 1 | |
| | | 1 | | 1 | 1 | RF | | 2 | |
| | 2 | | | 1 | | 1 | | | |

| | | | |
|--|--------------------|----|--|
| | 1200× 1000× 144 mm | 10 | |
| | | | |

3

60

4

| | | | — | |
|--|--|--|---|----|
| | | | — | |
| | | | — | |
| | | | — | |
| | | | | |
| | | | | |
| | | | | |
| | | | | |
| | | | | |
| | | | | -5 |
| | | | | |
| | | | | |
| | | | | -5 |
| | | | | |
| | | | | |
| | | | | -5 |
| | | | — | |
| | | | | |
| | | | | |

6.

4-6

1

| | | | () | | |
|---|--|-----|-----|---|--|
| 1 | | | 2 | 3 | |
| 2 | | | 298 | 4 | |
| 3 | | | 5 | 2 | |
| | | --- | --- | | |

2015. 10. 26

| | | | () | | |
|---|--|-----|-----|---|--|
| 1 | | | 2 | 2 | |
| 2 | | | 298 | 5 | |
| | | --- | --- | | |

2015. 10. 26

| | | | () | | |
|---|--|--|-----|---|--|
| 1 | | | 2 | 2 | |
| 2 | | | 298 | 6 | |
| 3 | | | 5 | 1 | |

| | | | | | |
|--|--|--|--|--|--|
| | | | | | |
|--|--|--|--|--|--|

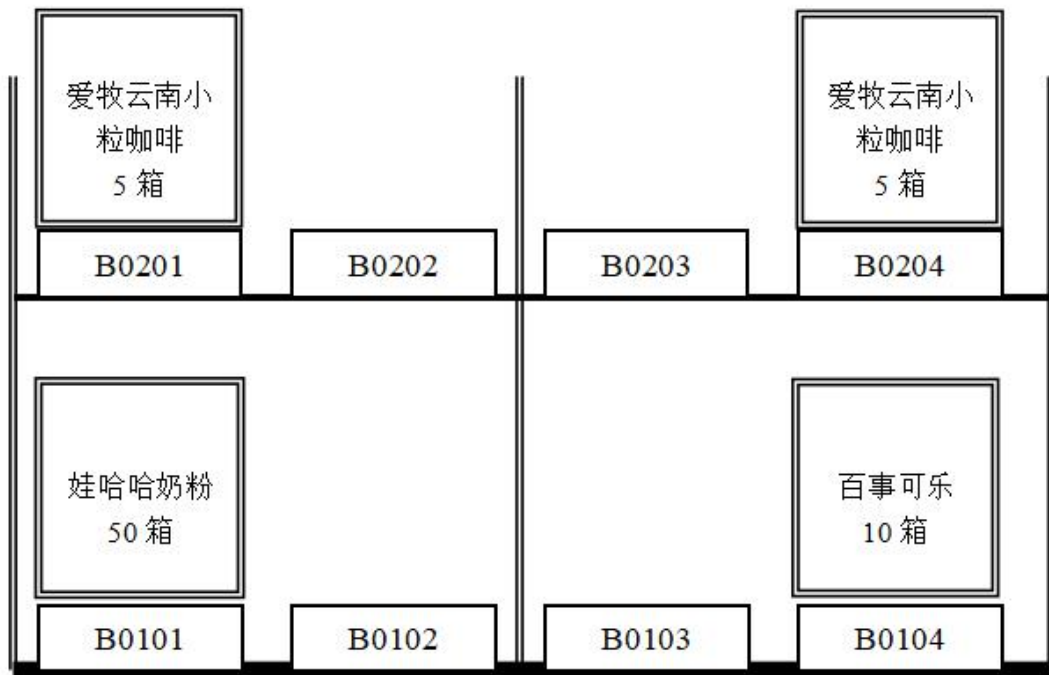

- a. WWS
- b.

- c.
- d.
- e
- f.
- g.
- h.

RF

| | | | () | | |
|---|--|--|-----|---|--|
| 1 | | | 4.5 | 3 | |
| 2 | | | 2 | 4 | |
| 3 | | | 3 | 5 | |
| 4 | | | 3 | 2 | |
| | | | | | |

- a.
- b
- c.
- d.

2

| | 1 | | | | | | |
|--|---|---|------|---|----|---|---|
| | 2 | 2 | 2x 2 | | 1 | | 1 |
| | | | 2 | 1 | | 1 | 1 |
| | | 1 | 1 | 1 | RF | 2 | |

| | | | | |
|--|--------------------|----|----|--|
| | 2 | 1 | 1 | |
| | 1200× 1000× 144 mm | 10 | 10 | |
| | | 2 | 1 | |

3

60

4

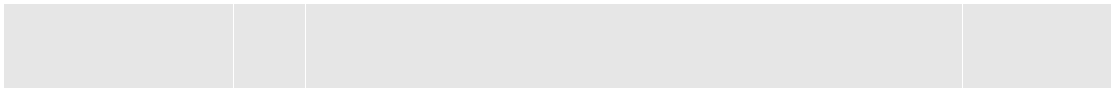

3

2

20

5

7S

7S

10

0

| | | | | | | |
|----|----|--|-------|---|---|---|
| | | | | 3 | | |
| | 10 | | | 2 | | |
| | | | | 2 | | |
| | 10 | | VWS | 6 | 2 | 2 |
| | | | | 2 | | |
| | 10 | | | 3 | 2 | 3 |
| | | | | 2 | | |
| 30 | 5 | | | 2 | | |
| | | | (VWS) | 1 | 2 | |
| | 15 | | (DPS) | 2 | 8 | |
| | | | | | 2 | 3 |
| | 10 | | | 2 | | 4 |
| | | | | 4 | | |
| | | | 2 | | | |
| | | | | | | |

7.

4-7

1

| | | | () | | |
|---|--|-----|------|---|--|
| 1 | | | 2 | 3 | |
| 2 | | | 298 | 5 | |
| 3 | | | 3 | 1 | |
| | | --- | ---- | | |

| | | | () | | |
|---|--|-----|------|---|--|
| 1 | | | 2 | 3 | |
| 2 | | | 298 | 6 | |
| 3 | | | 3 | 2 | |
| | | --- | ---- | | |

| | | | () | | |
|---|--|-----|------|---|--|
| 1 | | | 2 | 4 | |
| 2 | | | 298 | 1 | |
| 3 | | | 3 | 4 | |
| | | --- | ---- | | |

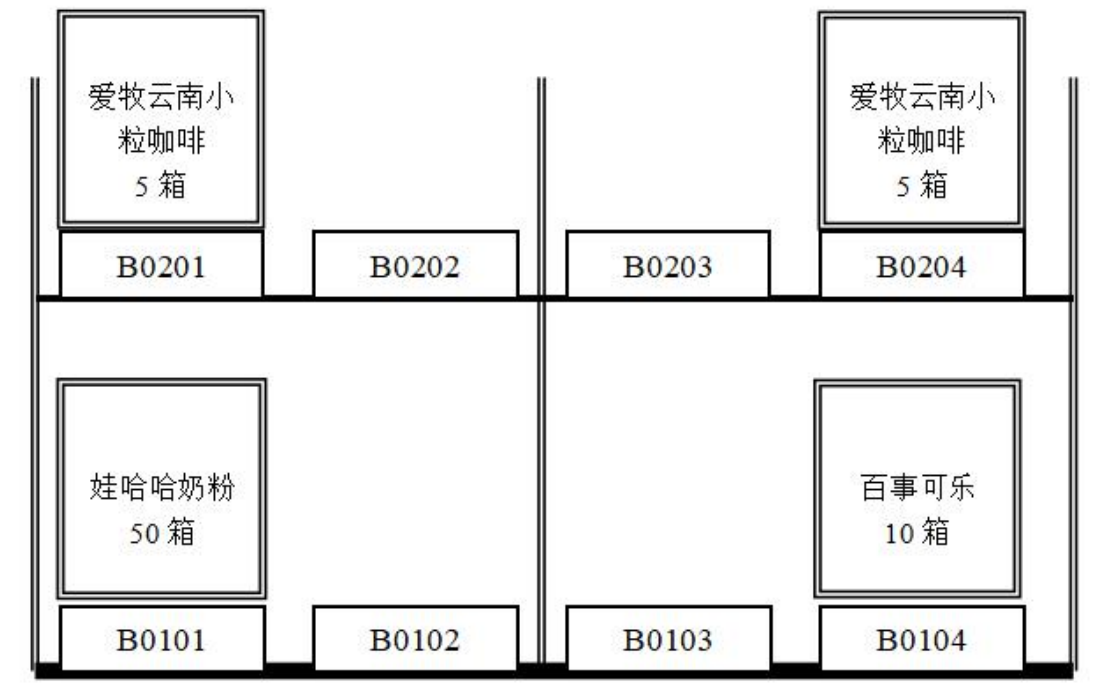

a. W\$

b

c.

d.

e.

RF

f.

g.

h.

| | | | () | | |
|---|--|-----|-----|---|--|
| 1 | | | 5 | 2 | |
| 2 | | | 2 | 3 | |
| 3 | | | 4.5 | 3 | |
| 4 | | | 3 | 1 | |
| | | --- | --- | | |

a.

b

c.

d.

| | | | | | | |
|--|-------|-------|--------|----|----|----|
| | | | | | | |
| | | 1 | | | | |
| | 2 | 2 | 2x 2 | | 1 | 1 |
| | | | 2 | 1 | 1 | 1 |
| | | 1 | 1 | 1 | RF | 2 |
| | 2 | | 1 | | 1 | |
| | 1200x | 1000x | 144 mm | 10 | | 10 |
| | | | 2 | | 1 | |

3

60

4

| | | | | | | |
|----|--|----|-----|-----|----|----|
| | | | | | | |
| | | | | | 3 | |
| | | 20 | | | | 2 |
| | | | | | | 5 |
| | | | 7S | | 7S | 10 |
| | | | | | | 1 |
| | | 5 | | | | 2 |
| | | | | | | 2 |
| | | | VWS | | 1 | 2 |
| | | 5 | | | 2 | |
| | | | | | | 1 |
| 50 | | | | VWS | | 4 |
| | | 5 | | | 1 | |
| | | | VWS | | | |
| | | | | | | 0 |

| | | | | | |
|----|----|-------|-----|-----|---|
| | 15 | | 2 | | |
| | | (RF) | 2 | | |
| | | | 2 | 1 3 | |
| | | (RF) | 1 3 | RF | |
| | | | 3 | | |
| | | | | | |
| | 10 | | 2 | | |
| | | | | 2 | |
| | | 6 | | | |
| | | 2 | | | |
| | 10 | VWS | | 2 | |
| | | | | 3 | |
| | | 3 | | | |
| | | | | 2 | |
| 30 | 5 | | | 2 | |
| | | (VWS) | 1 | 2 | |
| | 15 | (DPS) | 2 | 8 | |
| | | | | 2 | 3 |
| | | | | | 2 |
| | 10 | | | | 4 |
| | | | 4 | | |
| | | | 2 | | |
| | | | | | |

8.

4-8

1

| | | | () | | |
|---|--|-----|-----|---|--|
| 1 | | | 60 | 2 | |
| 2 | | | 298 | 2 | |
| 3 | | | 3 | 1 | |
| | | --- | --- | | |

| | | | () | | |
|---|--|-----|-----|---|--|
| 1 | | | 298 | 3 | |
| 2 | | | 3 | 1 | |
| | | --- | --- | | |

| | | | () | | |
|---|--|-----|-----|---|--|
| 1 | | | 60 | 3 | |
| 2 | | | 298 | 3 | |
| 3 | | | 3 | 1 | |
| | | --- | --- | | |

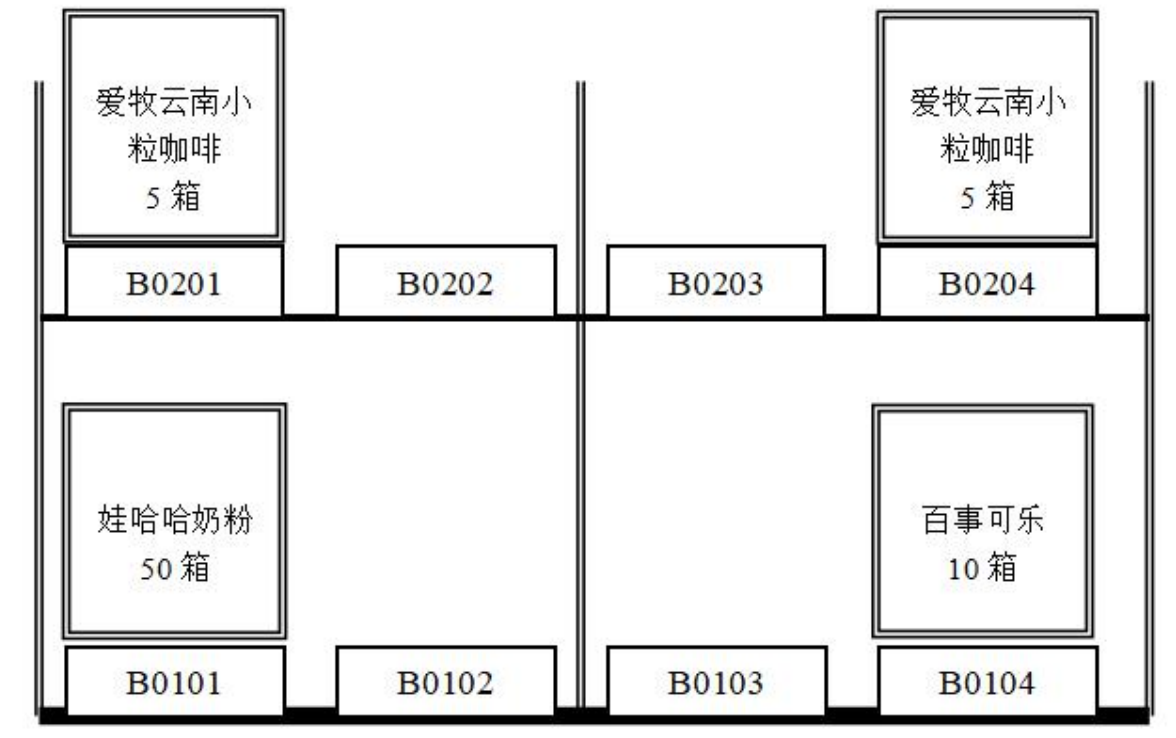

a. W&S

b

c.

d.

e.

RF

f.

g.

h.

| | | | () | | |
|---|--|-----|-----|---|--|
| 1 | | | 5 | 1 | |
| 2 | | | 2 | 3 | |
| 3 | | | 3 | 2 | |
| 4 | | | 3 | 2 | |
| | | --- | --- | | |

a.

b

c.

d.

| | 1 | |
|--|--------------------------|--|
| | 2 2 2× 2 1 1 | |
| | 2 1 1 1 RF 1 1 | |
| | 2 1 1 | |
| | 1200× 1000× 144 mm 10 10 | |
| | 2 1 | |

3

60

4

| | 20 | | 3 2 | |
|----|----|-----|-------|---|
| | | | 5 | |
| | | 7S | 7S 10 | |
| | 5 | | 1 2 2 | |
| | 5 | VWS | 1 2 | |
| | | | 2 1 | |
| 50 | 5 | VWS | 4 | 0 |

| | | | | | |
|----|--|----|-------|----------------|--------|
| | | | VWS | 1 | |
| | | 15 | | 2 | |
| | | | (RF) | 2 | |
| | | | | 1 3 | |
| | | | (RF) | 1 3 RF 3 | |
| | | 10 | | 2 | |
| | | | | 6 2 | 2 |
| | | 10 | VWS | | 2 3 |
| | | | | 3 | |
| 30 | | 5 | | | 2 |
| | | | (VWS) | 1 | 2 |
| | | 15 | (DPS) | 2 8 | |
| | | | | | 2 3 |
| | | | | 2 | |
| | | 10 | | | 4 |
| | | | 4 | 2 | |
| | | | | | |

9.



| | | | | | |
|---|--|--|-----|---|--|
| 2 | | | 298 | 4 | |
| 3 | | | 3 | 2 | |
| | | | | | |

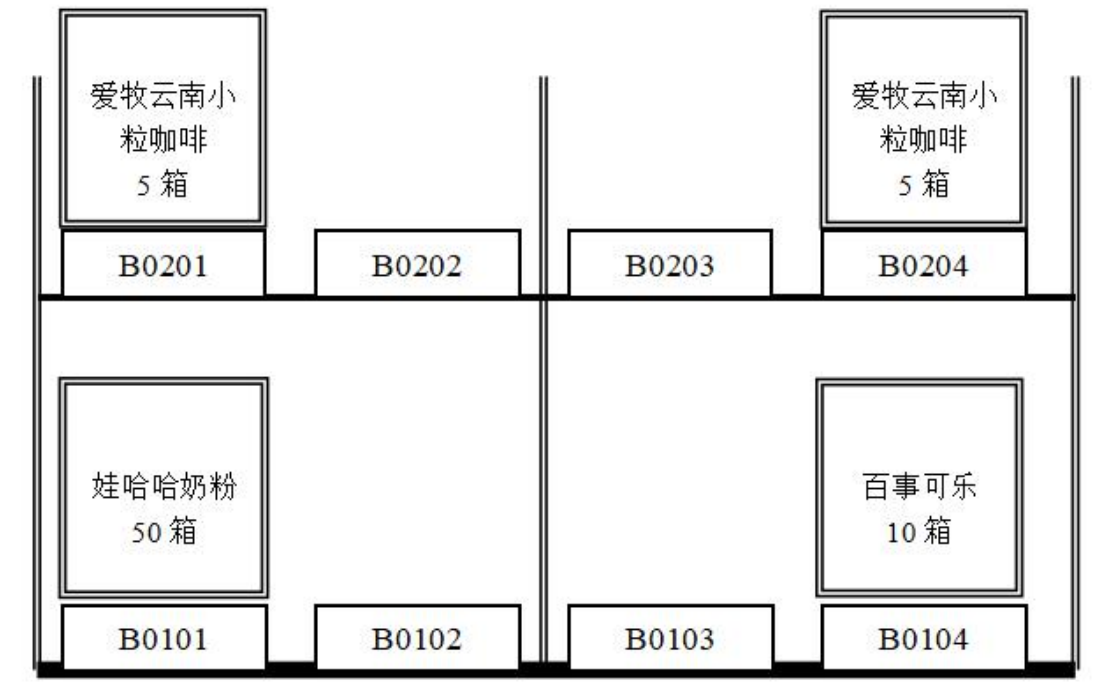

a. $\mathbb{W}\$$

b.

c.

d.

e.

RF

f.

g.

h.

| | | | () | | |
|---|--|-----|-----|---|--|
| 1 | | | 2 | 2 | |
| 2 | | | 2 | 4 | |
| 3 | | | 4.5 | 2 | |
| | | --- | --- | | |

a.

b.

c.

d.

2

| | | |
|--|--|--|
| | | |
|--|--|--|

| | | |
|--|--------------------------|--|
| | 1 | |
| | 2 2 2x 2 1 1 | |
| | 2 1 1 1 RF 2 1 | |
| | 2 1 1 | |
| | 1200x 1000x 144 mm 10 10 | |
| | 2 1 | |

3

60

4

| | 20 | | 3 | 2 |
|----|------|-----|----|----|
| | | | | 5 |
| | | 7S | 7S | 10 |
| 50 | 5 | | 1 | 2 |
| | | | | 2 |
| | 5 | WWS | 1 | 2 |
| | | | 2 | 1 |
| | 5 | WWS | | 4 |
| | | WWS | 1 | |
| 15 | | | 2 | |
| | (RF) | 2 | 2 | |

| | | | | | |
|----|----|------|--------|----|---|
| | | | | 1 | 3 |
| | | | (RF) | 1 | 3 |
| | 10 | | | RF | 3 |
| | | | | 2 | 2 |
| | 10 | VW\$ | | 6 | 2 |
| | | | | 2 | |
| 30 | 5 | | | | 2 |
| | | | (VW\$) | 1 | 2 |
| | 15 | | (DPS) | 2 | 8 |
| | | | | | 2 |
| | 10 | | | | 3 |
| | | | | 2 | |
| | | | | 4 | |
| | | | 4 | 2 | |
| | | | | | |

10.

4-10

1

| | | | () | | |
|---|--|-----|-----|---|--|
| 1 | | | 60 | 3 | |
| 2 | | | 298 | 2 | |
| 3 | | | 3 | 2 | |
| | | --- | --- | | |

| | | | () | | |
|---|--|-----|-----|---|--|
| 1 | | | 60 | 2 | |
| 2 | | | 298 | 3 | |
| | | --- | --- | | |

| | | | () | | |
|---|--|-----|-----|---|--|
| 1 | | | 298 | 4 | |
| 2 | | | 3 | 2 | |
| | | --- | --- | | |

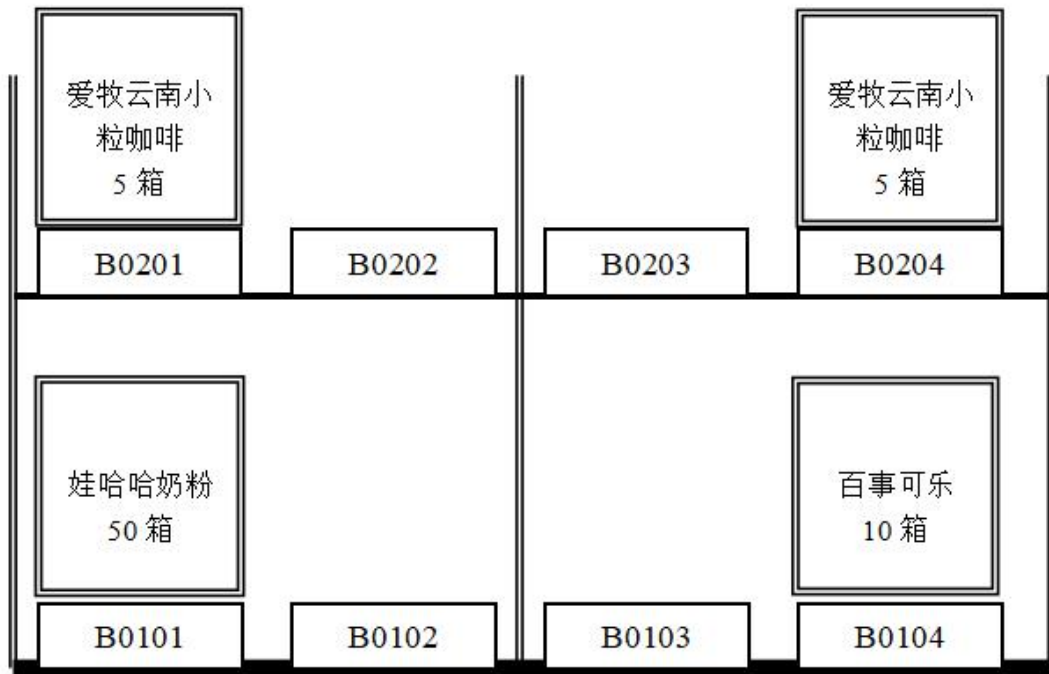

a. W\$

b

c.

d.

e.

RF

f.

g.

h.

| | | | () | | |
|---|--|-----|-----|---|--|
| 1 | | | 4.5 | 2 | |
| 2 | | | 2 | 3 | |
| 3 | | | 3 | 1 | |
| 4 | | | 3 | 2 | |
| | | --- | --- | | |

a.

b

c.

d.



| | | | | | | |
|---|---|------|---|---|---|---|
| | | 1 | | | | |
| 2 | 2 | 2x 2 | | 1 | | 1 |
| | | 2 | 1 | | 1 | - |

| | | | | | |
|----|--|----|-------|----------------|--------|
| | | | VWS | 1 | |
| | | 15 | | 2 | |
| | | | (RF) | 2 | |
| | | | | 1 3 | |
| | | | (RF) | 1 3 RF 3 | |
| | | 10 | | 2 | |
| | | | | 6 2 | 2 |
| | | 10 | VWS | | 2 3 |
| | | | | 3 | |
| 30 | | 5 | | | 2 |
| | | | (VWS) | 1 | 2 |
| | | 15 | (DPS) | 2 8 | |
| | | | | | 2 3 |
| | | | | 2 | |
| | | 10 | | | 4 |
| | | | 4 | 2 | |
| | | | | | |

11.

4-11

| | | | () | | |
|---|--|-----|-----|---|--|
| 1 | | | 60 | 2 | |
| 2 | | | 3 | 2 | |
| | | --- | --- | | |

| | | | () | | |
|---|--|-----|-----|---|--|
| 1 | | | 60 | 3 | |
| 2 | | | 298 | 8 | |
| | | --- | --- | | |

| | | | () | | |
|---|--|-----|-----|---|--|
| 1 | | | 298 | 4 | |
| 2 | | | 3 | 3 | |
| | | --- | --- | | |

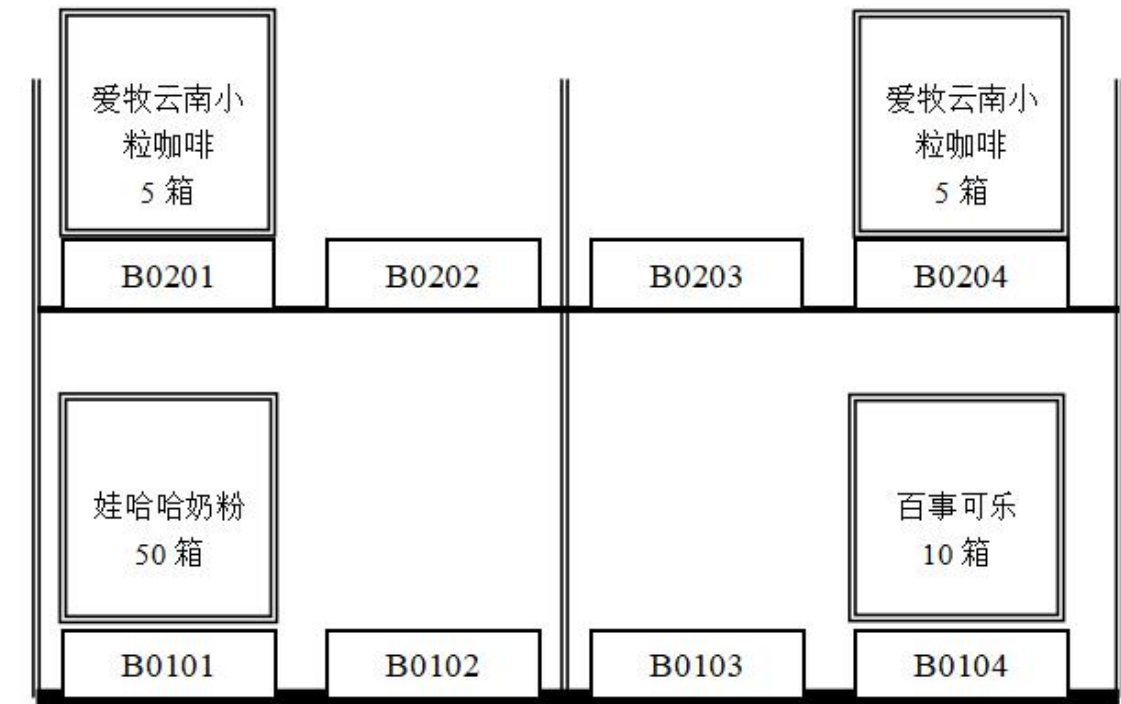

a. W\$

b

- c.
- d.
- e.
- f.
- g.
- h.

RF

| | | | () | | |
|---|--|--|-----|---|--|
| 1 | | | 4.5 | 1 | |
| 2 | | | 2 | 2 | |
| 3 | | | 3 | 4 | |
| 4 | | | 3 | 2 | |
| | | | | | |

- a.
- b.
- c.
- d.

2

| | | |
|--|--|--|
| | | |
|--|--|--|

| | | |
|--|--------------------------|--|
| | 1 | |
| | 2 2 2x 2 1 1 | |
| | 2 1 1 1 RF 2 1 | |
| | 2 1 1 | |
| | 1200x 1000x 144 mm 10 10 | |
| | 2 1 | |

3

60

4

| | 20 | | 3 | 0 |
|----|------|-----|-------|---|
| | | | 2 | |
| | | | 5 | |
| | | 7S | 7S 10 | |
| 50 | 5 | | 1 | 0 |
| | | | 2 | |
| | 5 | VWS | 1 2 | |
| | | | 2 1 | |
| | 5 | VWS | 4 | |
| | | VWS | 1 | |
| 15 | | 2 | | |
| | (RF) | 2 | | |

| | | | | | |
|----|----|------|--------|----|---|
| | | | | 1 | 3 |
| | | | (RF) | 1 | 3 |
| | 10 | | | RF | 3 |
| | | | | 2 | 2 |
| | 10 | VW\$ | | 6 | 2 |
| | | | | 2 | |
| 30 | 5 | | | | 2 |
| | | | (VW\$) | 1 | 2 |
| | 15 | | (DPS) | 2 | 8 |
| | | | | | 2 |
| | 10 | | | | 3 |
| | | | | 2 | |
| | | | | 4 | |
| | | | 4 | 2 | |
| | | | | | |

12

4-12

1

| | | | () | | |
|---|--|-----|-----|---|--|
| 1 | | | 2 | 3 | |
| 2 | | | 298 | 3 | |
| | | --- | --- | | |

| | | | () | | |
|---|--|-----|-----|---|--|
| 1 | | | 2 | 7 | |
| 2 | | | 298 | 2 | |
| | | --- | --- | | |

| | | | () | | |
|---|--|-----|-----|---|--|
| 1 | | | 298 | 4 | |
| 2 | | | 5 | 5 | |
| | | --- | --- | | |

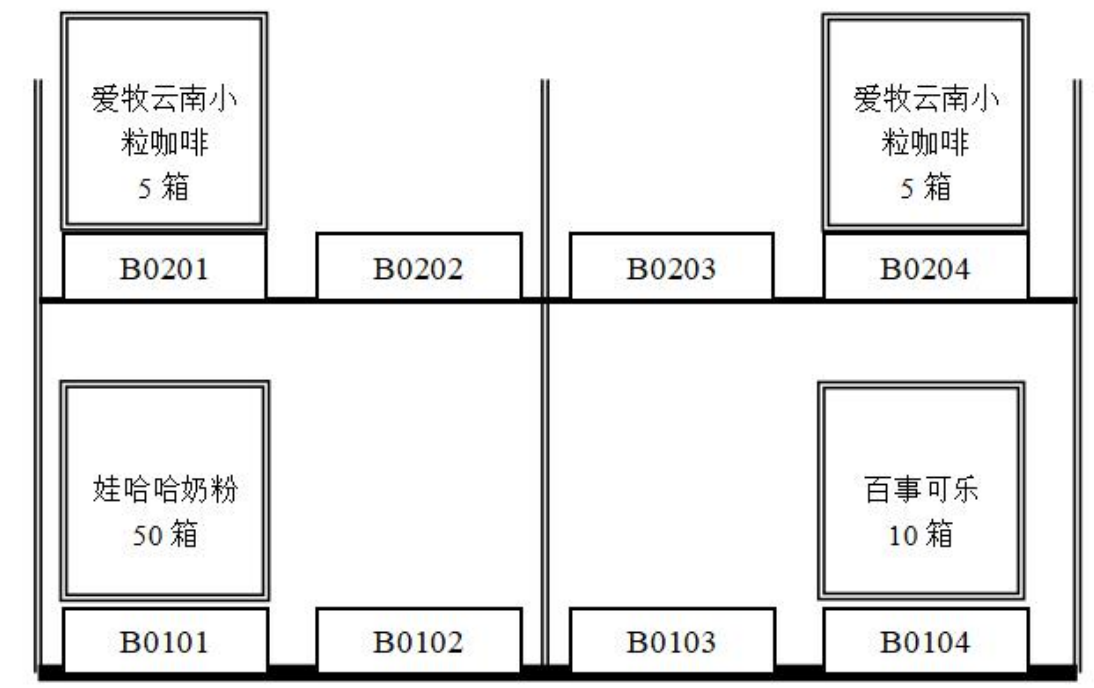

a. W\$

b.

c.

d.

e.

RF

f.

g.

h.

| | | | () | | | |
|---|--|-----|-----|---|--|---|
| 1 | | | 4.5 | 2 | | 1 |
| 2 | | | 2 | 2 | | 2 |
| 3 | | | 3 | 3 | | 3 |
| 4 | | | 3 | 1 | | 4 |
| | | --- | --- | | | |

a.

b.

c.

d.



1
2 2 2× 2 1 1
2 1 1 1 RF 1 1
2 1 1
1200× 1000× 144 mm 10 10

2

| | | | () | | |
|---|--|-----|-----|---|--|
| 1 | | | 5 | 3 | |
| 2 | | | 298 | 4 | |
| 3 | | | 3 | 2 | |
| | | --- | --- | | |

| | | | () | | |
|---|--|-----|-----|---|--|
| 1 | | | 5 | 2 | |
| 2 | | | 298 | 3 | |
| 3 | | | 3 | 1 | |
| | | --- | --- | | |

| | | | () | | |
|---|--|-----|-----|---|--|
| 1 | | | 5 | 1 | |
| 2 | | | 298 | 2 | |
| 3 | | | 3 | 3 | |
| | | --- | --- | | |

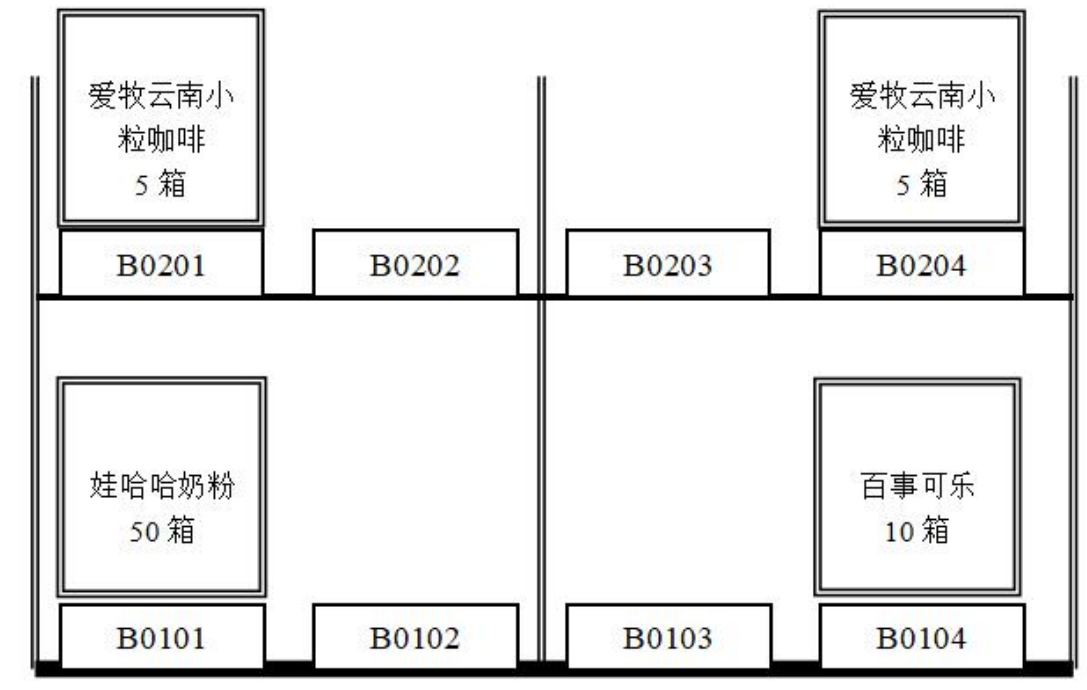

a. WWS

- b.
- c.
- d.
- e.
- f.
- g.
- h.

RF

| | | | () | | |
|---|--|--|-----|---|---|
| 1 | | | 4.5 | 4 | 1 |
| 2 | | | 2 | 3 | 2 |
| 3 | | | 3 | 1 | 3 |
| 4 | | | 3 | 2 | 4 |
| | | | | | |

- a.
- b.
- c.
- d.

| | | |
|--|-----------------------------------------|--|
| | | |
| | 1 | |
| | 2 2 2x 2 1 1 2 1 1 1 RF 1 1 2 1 1 | |
| | 1200x 1000x 144 mm 10 10 | |
| | 2 1 | |

3

60

4

| | | | | |
|----|----|-----|-------|---|
| | | | | |
| | | | 3 | |
| | 20 | | 2 | |
| | | | 5 | |
| | | 7S | 7S 10 | |
| | 5 | | 1 | |
| | | | 2 | |
| | | | 2 | |
| | 5 | VWS | 1 2 | |
| | | | 2 | |
| | | | 1 | |
| | 5 | VWS | 4 | |
| 50 | | | 1 | |
| | 5 | VWS | | |
| | 15 | | 2 | |
| | | | | 0 |

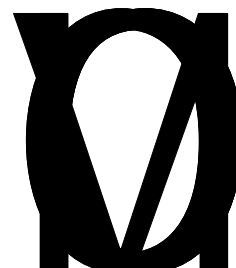
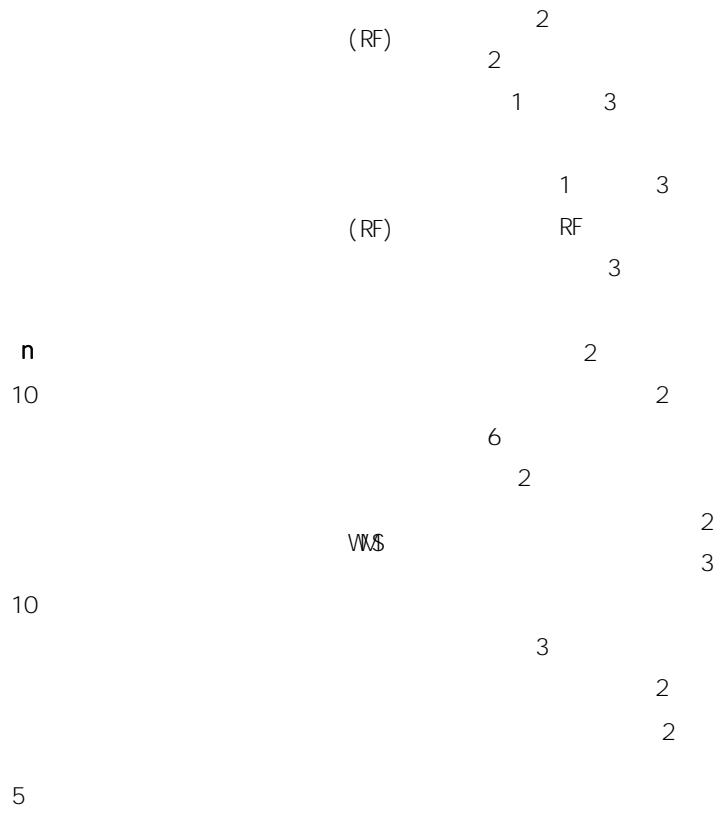

1

| | | | () | | |
|---|--|-----|------|---|--|
| 1 | | | 5 | 3 | |
| 2 | | | 298 | 1 | |
| | | --- | ---- | | |

| | | | () | | |
|---|--|-----|------|---|--|
| 1 | | | 5 | 2 | |
| 2 | | | 298 | 2 | |
| 3 | | | 2 | 6 | |
| | | --- | ---- | | |

| | | | () | | |
|---|--|-----|------|---|--|
| 1 | | | 5 | 2 | |
| 2 | | | 298 | 4 | |
| 3 | | | 2 | 4 | |
| | | --- | ---- | | |

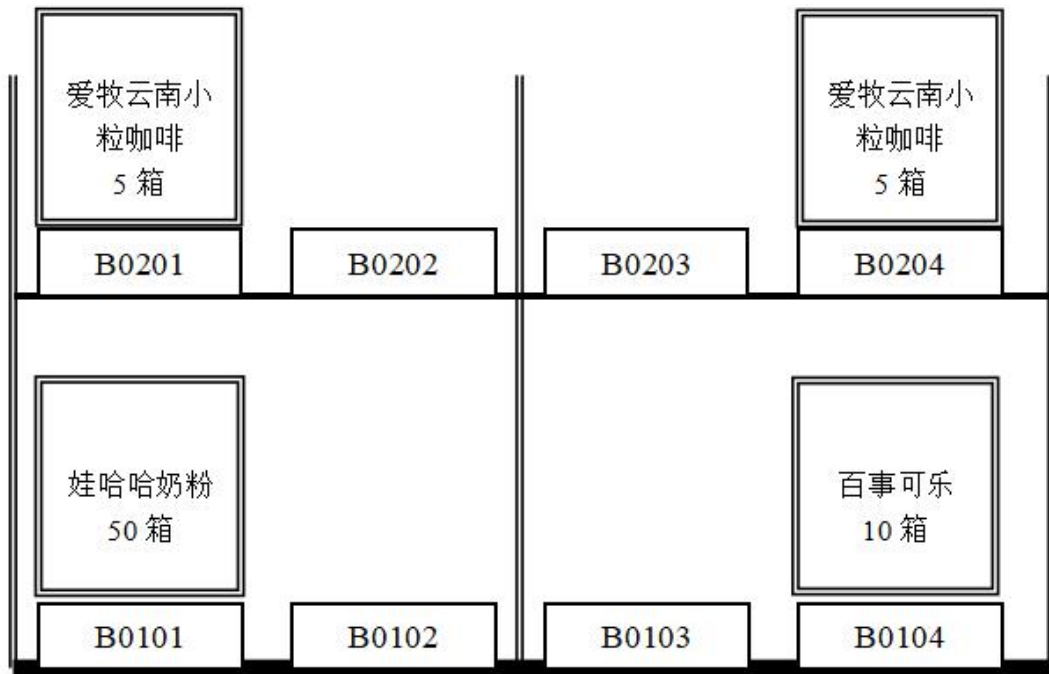

- a. $\mathbb{W}\$$
- b.
- c.
- d.
- e.
- f.
- g.
- h.

RF

| | | | () | | |
|---|--|--|-----|---|--|
| 1 | | | 4.5 | 2 | |
| 2 | | | 2 | 1 | |
| 3 | | | 3 | 3 | |
| 4 | | | 3 | 1 | |
| | | | | | |

- a.
- b.
- c.
- d.

| | | | | | | | | |
|--|-------|-------|--------|---|----|----|----|---|
| | | | | | | | | |
| | | 1 | | | | | | |
| | 2 | 2 | 2× 2 | | 1 | | 1 | |
| | | | 2 | | 1 | | 1 | 1 |
| | | 1 | | 1 | 1 | RF | 2 | |
| | 2 | | | 1 | | 1 | | |
| | 1200× | 1000× | 144 mm | | 10 | | 10 | |
| | | | 2 | | 1 | | | |

3

60

4

| | | | | | | | |
|----|--|----|-----|-----|----|----|---|
| | | | | | | | |
| | | | | | | | |
| | | | | | 3 | | |
| | | 20 | | | | 2 | |
| | | | | | | 5 | |
| | | | 7S | | 7S | 10 | |
| | | | | | | 1 | |
| | | 5 | | | | 2 | |
| | | | | | | 2 | |
| | | | VWS | | 1 | 2 | |
| | | 5 | | | 2 | | |
| | | | | | | 1 | |
| 50 | | 5 | | VWS | | | 4 |
| | | | | | | | 0 |

| | | | | | | |
|----|--|----|-------|-----------|--------|---|
| | | | VWS | 1 | | |
| | | 15 | | 2 | | |
| | | | (RF) | 2 | | |
| | | | | 1 3 | | |
| | | | (RF) | 1 3 RF | | |
| | | 10 | | 2 | | |
| | | | | 6 2 | | |
| | | 10 | VWS | | 2 3 | |
| | | | | 3 | | 2 |
| 30 | | 5 | | | 2 | |
| | | | (VWS) | 1 | 2 | |
| | | 15 | (DPS) | 2 8 | | |
| | | | | | 2 3 | |
| | | | | 2 | | |
| | | 10 | | | 4 | |
| | | | 4 | 2 | | |
| | | | | | | |

15.

4-15

| | | | () | | |
|---|--|-----|-----|---|--|
| 1 | | | 60 | 1 | |
| 2 | | | 5 | 5 | |
| | | --- | --- | | |

| | | | () | | |
|---|--|-----|-----|---|--|
| 1 | | | 60 | 2 | |
| 2 | | | 5 | 5 | |
| | | --- | --- | | |

| | | | () | | |
|---|--|-----|-----|---|--|
| 1 | | | 60 | 2 | |
| 2 | | | 3 | 4 | |
| | | --- | --- | | |



- a. VW\$
- b.
- c.
- d.
- e. RF
- f.
- g.
- h.

| | | | () | | |
|---|--|-----|-----|---|--|
| 1 | | | 2 | 3 | |
| 2 | | | 3 | 8 | |
| 3 | | | 3 | 3 | |
| | | --- | --- | | |

- a.
- b.
- c.
- d.

2

| | | |
|--|--|--|
| | | |
|--|--|--|

| | | |
|--|--------------------------|--|
| | 1 | |
| | 2 2 2x 2 1 1 | |
| | 2 1 1 1 RF 2 1 | |
| | 2 1 1 | |
| | 1200x 1000x 144 mm 10 10 | |
| | 2 1 | |

3

60

4

| | 20 | | 3 2 5 7S 10 | |
|----|----|-----|-------------|---|
| 50 | 5 | | 1 2 2 | 0 |
| | | VWS | 1 2 2 1 | |
| | 5 | VWS | 4 | |
| | | VWS | 1 | |
| | 15 | | 2 | |

30

| | | | |
|----|-------|----|---|
| | (RF) | 2 | |
| | | 2 | |
| | | 1 | 3 |
| | (RF) | 1 | 3 |
| | | RF | |
| | | | 3 |
| | | 2 | |
| 10 | | | 2 |
| | | 6 | |
| | | 2 | |
| | W\$ | | 2 |
| 10 | | | 3 |
| | | 3 | |
| | | | 2 |
| | | | 2 |
| 5 | | | 1 |
| | (W\$) | | 2 |
| | (DPS) | 2 | 8 |
| 15 | | | 2 |
| | | | 3 |
| | | 2 | |
| | | | 4 |
| 10 | | 4 | |
| | | | 2 |

1

1

- a.
- b.
- c.
- d.

TACT RATES BOOKS

" 1893"

320

102 cmx 44 cmx 25cmx 5

6000

1

| SHANGHAI Y. RENMINGBI | | CN CNY | SHJ KGS |
|--------------------------|------|-----------|------------|
| OSAKA | JP | M | 230. 00 |
| | | N | 37. 51 |
| | | 45 | 28. 13 |
| | 0008 | 300 | 18. 80 |
| | 0300 | 500 | 20. 61 |
| | 1893 | 300 | 18. 43 |

2

2

| | | |
|--|---|----|
| | | |
| | 2 | 30 |

| | | | | |
|--|--------|----|----|--|
| | 1 | 30 | 40 | |
| | Office | 5 | | |
| | | 30 | | |
| | 30 | 2 | | |

3

90

4

| | | | | |
|-------|----|-----|----|----|
| | | | | |
| (20) | 5 | | 5 | 0 |
| | 5 | | 1 | |
| | 10 | | 4 | |
| (80) | | | 5 | |
| | 15 | | 5 | |
| | 10 | | 15 | |
| | | | 10 | |
| | | ISO | | |
| | 10 | | 2 | 8 |
| | 20 | | 10 | 10 |
| | | | 10 | |

| | | | | | |
|--|--|----|--|----|----|
| | | | | | |
| | | 25 | | 10 | |
| | | | | | 10 |
| | | | | | 5 |

2

5-2

1

1

:
 :
 : XX XX XX
 : Cl F
 :
 : 35
 : 40
 : 40

| | | |
|---|---|---|
| 1 | | |
| | | |
| | | |
| 2 | 4 | 5 |
| | | 6 |
| | | / |
| 3 | | |
| | | |

7

8

40m3

35T

ISO

1m× 1m× 1m

1AA

1CC

USD1 000/TEU USD1 800/FEU

XFT

2002/C NO 245789

NEW YORK

NO 1—40

35

40

40

300 /

WM

2

2

| | | |
|--|----------|-------|
| | | |
| | 2 | 30 |
| | 1 | 30 40 |
| | Office 5 | |
| | 30 | |
| | 30 | 2 |

| | | |
|--|--|--|
| | | |
|--|--|--|

3

90

4

5

5

1

5

(20)

4

5

0

10

5

20

5

15

20

20

(80)

ISO

15

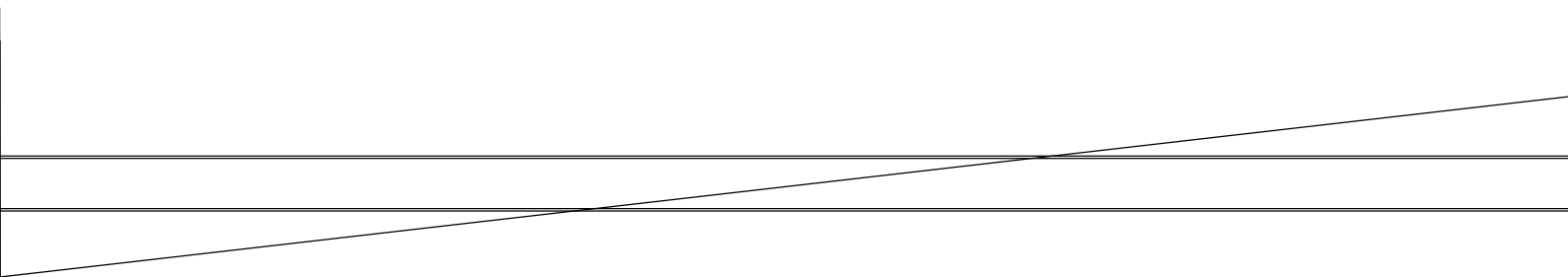

3.

5-3

1

1

"

"

a.

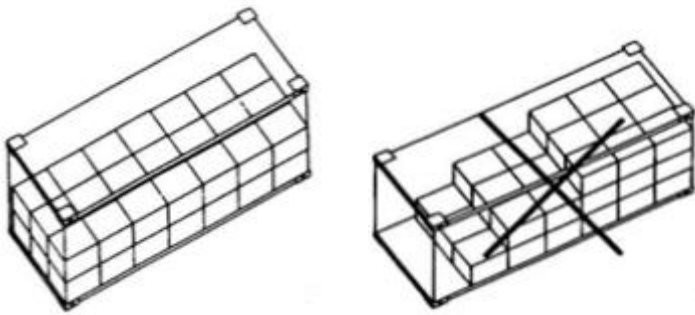

b.

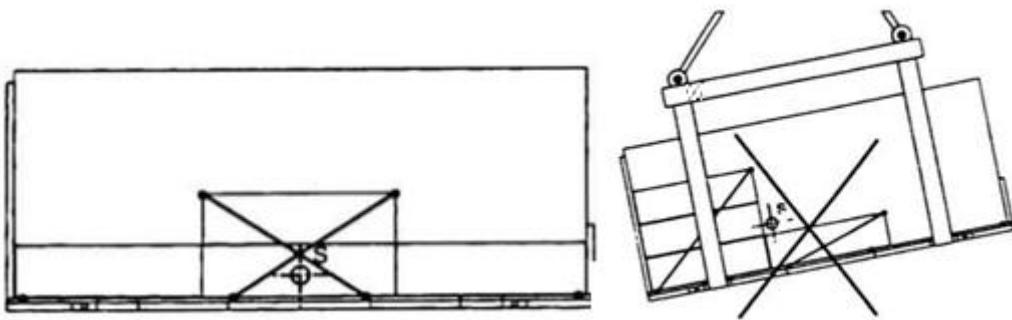

c.

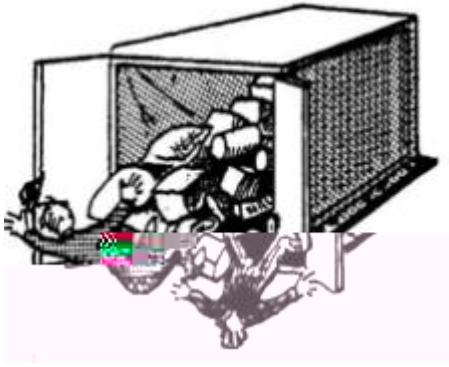

d.

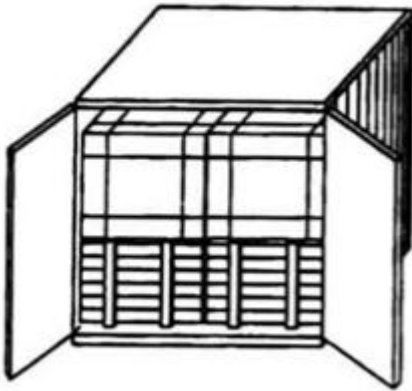

SMCO

2002/C NO. 245789

NEW YORK

NO. 1—20

20ft

19.5m³

15t

USD18.5M

21.5t

2

2

2

30

| | | |
|--|--|--|
| | | |
|--|--|--|

3

90

4

| | | | | |
|-------|----|----|---------|---|
| | | | | |
| (20) | 5 | | 5 | 0 |
| | 5 | | 1 | |
| | 10 | | 4 5 | |
| (80) | | 15 | 5 10 | |
| | | 10 | 10 | |
| | | 10 | ISO 2 8 | |
| | | 15 | 10 5 | |

| | | | |
|--|----|---|--------|
| | 15 | | 15 |
| | 15 | 5 | 8 2 |

4. 5-4

1

1

A

B

| 船公司 Carrier | 船名/航次 Vessel | 服务代码 Service | 航线 Lane | 装船港/卸船港 Load/Unload Port | 启-达日期 ETD-ETA | 天 Day |
|--------------------|-----------------------------|------------------------|------------------|---------------------------------|----------------------|----------|
| MSC 地中海航运 | MASTER 1409K | | 中国-港澳台 | HONG KONG 香港 KAOHSIUNG 高雄 | 02/25(二) 03/13(六) | 18 |
| NYK 日本邮船 | ITALIAN EXPRES S/024 | | 中国-东南亚 | HONG KONG 香港 BANGKOK 曼谷 | 02/23(二) 03/02(日) | 5 |
| CMA-CGM 达飞轮船 | CMA CGM GEMINI 11A49E | | 中国-欧洲 | XIAMEN 厦门 DUREAN 德班 | 02/25(二) 03/27(四) | 30 |
| KLINE 川崎汽船 | HYUNDAI PLATINUM M/004W | | 中国-东南亚 | SHANGHAI 上海 PAMANAGUA 巴拉那瓜 | 02/25(二) 04/09(三) | 43 |
| DMS 达茂轮船 | COSCO KAOHSIUNG S/GFB46E | | 中国-澳洲 | HONG KONG 香港 NOUMEA 努美阿 | 02/25(二) 04/02(三) | 36 |
| FCL 长海储运 | KOTA PERMASAN VFM114 | | 中国-中东/ 波斯湾/印巴 | QINGDAO 青岛 MADRAS 马德拉斯 | 02/28(五) 03/18(二) | 18 |
| ZIM 以星轮船 | KUO HUNG 311 | CHINA_VIETNAM(CVX) | 中国-港澳台 | NINGBO 宁波 HONG KONG 香港 | 02/25(二) 03/13(六) | 18 |
| SAFMARINE 比利时马敏 | HEIKE P 1404 | | 中国-非洲 | KAOHSIUNG 高雄 MINDELO | 02/25(二) 04/05(六) | 39 |
| CSAV 长荣轮船 | CAP SAN NICOLA S/01409 | | 中国-东南亚 | SHANGHAI 上海 RIO GRANDE 里奥格兰德 | 02/23(二) 04/07(一) | 41 |
| OOCL 东方海外 | DRESDEN EXPRES S/16808 | Pacific Atlantic (PAX) | 中国-澳洲 | SHANGHAI 上海 HALIFAX 哈利法克斯 | 02/25(二) 04/14(一) | 48 |

a. ETD ETA

b.

c.

A B — A
 20 17.8
 DURBAN CAPE TOWN
 USD80.0/FT USD3.0
 " WM

a. B A ?
 b. USD1100.0/TEU
 10 10 ()?
 c.

?
 2
 2
 2 30
 1 30 40
 Office 5
 30
 30 2

| | | | | | |
|-------|--|----|--|----------|---|
| (20) | | 5 | | 1 | 0 |
| | | 10 | | 4 5 5 | |
| (80) | | 10 | | 10 | |
| | | 15 | | 5 10 | |
| | | 10 | | 10 | |
| | | 15 | | 10 5 | |
| | | 15 | | 15 | |
| | | 15 | | 5 8 2 | |

5.

5-5

1

1

- a.
- b.
- c. " Nature and quantity of Goods" ,
- d.
- e.

Routing BEIJING CHINA BJS to BOSTON U.S.A BOS

Commodity Gold Watch

Gross Weight 32.0Kgs

Dimensions 1Piece 61X51X42CM

| BEIJING | CN | | BJS |
|----------------|-----|------|--------|
| Y. RENMINBI | CNY | | KGS |
| | | 100 | 14.93 |
| | | 200 | 29.86 |
| | | 300 | 44.79 |
| | | 400 | 59.72 |
| | | 500 | 74.65 |
| | | 600 | 89.58 |
| | | 700 | 104.51 |
| | | 800 | 119.44 |
| | | 900 | 134.37 |
| | | 1000 | 149.30 |

Normal GCR 200%

2

2

2

30

| | | | | |
|--|----|--|----|----|
| | | | | |
| | 20 | | 20 | |
| | 25 | | 10 | 10 |
| | | | 5 | |

6. 5-6

1

1)

Beijing textiles Imp. And Exp. Corp, M&I s Co., 126 Rome
street, Antwerp, Belgium Boy' s sport suit, 3600 , 20
CFR , , 10 , 50cm* 20cm* 30cm 10
/ , () : M&I S/ANTWERP/NOS: 1-30 2013 5 18
E0002 " MARRY"

:

"

"

"

"

BI LL OF LADI NG

Shi pper (1)

Consi gnee (2)

Noti fy Party (3)

Ocean Vessel (4)

Voy. S/O No. 898 B/L No. 567

Port of Loadi ng (5)

Port of Di scharge (6)

Freight payabl e at (7)

Parti cul ars furni shed by the Shi pper

| Marks and Numbers | No. of Packages | Description of goods | Gross Weight | Measurement |
|-------------------|-----------------|----------------------|--------------|-------------|
|-------------------|-----------------|----------------------|--------------|-------------|

3

90

4

| | | | | |
|-------|----|--|----|----|
| | | | | |
| (20) | 5 | | 5 | 0 |
| | 5 | | 1 | |
| | 10 | | 4 | |
| | | | 5 | |
| (80) | 20 | | | 20 |
| | 10 | | 5 | 5 |
| | 15 | | 9 | 6 |
| | 15 | | 15 | |
| | 20 | | 10 | 10 |

7.

5-7

1

1)

" full sets of original clean on board ocean bill of lading made out to order of Royal Bank Canada and marked Freight Prepaid notify applicant"

- a. 5
- b. 5
- c. 5

CIF

- a.
- b.
- c.

2013 8

CIF

2

2

| | | |
|--|----------|--|
| | | |
| | 2 30 | |
| | 1 30 40 | |
| | Office 5 | |
| | 30 | |
| | 30 2 | |

3

90

4

| | | | | |
|-------|----|--|-------|---|
| | | | | |
| (20) | 5 | | 5 | 0 |
| | 5 | | 1 | |
| | 10 | | 4 5 5 | |
| (80) | 20 | | 20 | |
| | 10 | | 5 5 | |
| | 15 | | 9 6 | |
| | 15 | | 7 8 | |
| | 20 | | 10 10 | |

8.

5-8

1

1)

Shipper ABC Co Ltd

consignee To Order

Notified Party XYZ Co Ltd

a.

b.

c.

d. XYZ Co Ltd

CI F

a.

b.

c.

ABC

XYZ

100

30

:

2012

ABC

XYZ

10

6

D/P

26

2013 3

4

a.

b.
2

2

| | | |
|--|--------|---------|
| | | |
| | 2 | 30 |
| | | 1 30 40 |
| | Office | 5 |
| | | 30 |
| | 30 | 2 |

3

90

4

| | | | | |
|-------|----|--|-------|---|
| | | | | |
| (20) | 5 | | 5 | 0 |
| | 5 | | 1 | |
| | 10 | | 4 5 5 | |
| (80) | 20 | | 20 | |
| | 10 | | 5 5 | |
| | 15 | | | |

| | | | | |
|--|----|--|----|----|
| | | | 9 | 6 |
| | 15 | | 7 | 8 |
| | 20 | | 10 | 10 |

9. 5-9

1

1)

Applicant Nissho Iwai Corporation No. 4-5 Akaasaka 2-Chome Minato-ku Tokyo Japan

Beneficiary China National Mine Import and Export Corp Beijing P. R. China

Pre-advise Bank of China Beijing Branch Full sets of clean on board marine bill of lading made out to order of shipper and blank endorsed and marked freight prepaid and notify applicant

(1) ?

(2) ?

(3) ?

CI F

(1)

(2)

(3)

2

2

| | | |
|--|--------|---------|
| | | |
| | 2 | 30 |
| | | 1 30 40 |
| | Office | 5 |
| | | 30 |
| | 30 | 2 |

3

90

4

| | | | |
|-------|----|----|-------|
| | | | |
| (20) | 5 | | 5 |
| | 5 | | 1 |
| | 10 | | 4 5 0 |
| (80) | | 20 | 5 20 |

| | | | | |
|--|----|--|----|----|
| | | | | |
| | 10 | | 5 | 5 |
| | 15 | | 9 | 6 |
| | 15 | | 8 | 7 |
| | 20 | | 10 | 10 |

10. 5-10

1

1)

:

Routing: SHANGHAI CHINA SHA to PARIS FRANCE PAR

Commodity TOY

Gross weight 5.6kgs

Dimensions 40cmx 28cmx 22cm

| | | |
|-------------|-----|-----|
| SHANGHAI | CN | SHA |
| Y. RENMINBI | CNY | Kgs |

| | | | |
|--------|----|------|--------|
| PARI S | FR | M | 320.00 |
| | | N | 50.22 |
| | | 45 | 41.43 |
| | | 300 | 37.90 |
| | | 500 | 33.42 |
| | | 1000 | 30.71 |

| No. of Pieces Rcp | Gross Weight | Kilob | Rate Class | Chargeable Weight | Rate / Charge | Total | Nature and Quantity of Goods (Incl. Dimension or Volume) |
|-------------------|--------------|-------|--------------------|-------------------|---------------|-------|----------------------------------------------------------|
| | | | Commodity Item No. | | | | |
| | | | | | | | |

2

2

| | | |
|--|----------|-------|
| | | |
| | 2 | 30 |
| | 1 | 30 40 |
| | Office 5 | |
| | 30 | |

| | | | |
|--|----|---|--|
| | 30 | 2 | |
|--|----|---|--|

3

90

4

| | | | | |
|-------|----|--|-------|---|
| | | | | |
| (20) | 5 | | 5 | 0 |
| | 5 | | 1 | |
| | 10 | | 4 5 5 | |
| (80) | 20 | | 20 | |
| | 10 | | 5 5 | |
| | 15 | | 9 6 | |
| | 15 | | 8 7 | |
| | 20 | | 10 10 | |

11. 5-11

1

2 20 JS " "

MM Al en

2 21 18: 00

100

2 21 18: 30

Al en

10

1)

?

| | | | |
|--|--|--|--|
| | | | |
| | | | |
| | | | |
| | | | |
| | | | |
| | | | |
| | | | |

: :"

18: 00 "

2009. 02. 21 02: 00

2 20

l i x i a n s h e n g @ 1 2 6 . c o m

2

| | | |
|--|--------|---------|
| | | |
| | 2 | 30 |
| | | 1 30 40 |
| | Office | 4 |
| | | 30 |
| | 30 | 2 |

3

90

4

| | | | | |
|-------|----|--|--------|---|
| | | | | |
| (20) | 5 | | 5 | 0 |
| | 5 | | 1 4 | |
| | 10 | | 5 5 | |
| (80) | 15 | | 8 7 | |
| | 15 | | 8 7 | |

| | | | | |
|--|----|--|------------------|--|
| | 15 | | 5 5 5 | |
| | 20 | | 5 5 5 5 | |
| | 15 | | 5 10 | |

12

5-12

1

A B

FOB

D

D

A

B

A

A

B

B

l i x i a n s h e n g @ 1 2 6 . c o m

2

2

| | | |
|--|--------|---------|
| | | |
| | 2 | 30 |
| | | 1 30 40 |
| | Office | 4 |
| | | 30 |
| | 30 | 2 |

3

90

4

| | | | | |
|-------|----|--|--------|---|
| | | | | |
| (20) | 5 | | 5 | 0 |
| | 5 | | 1 4 | |
| | 10 | | 5 5 | |
| (80) | 15 | | 8 7 | |
| | 15 | | 8 7 | |

| | | | | |
|--|----|--|------------------|--|
| | 15 | | 5 5 5 | |
| | 20 | | 5 5 5 5 | |
| | 15 | | 5 10 | |

13.

5-13

1

20 80

140

" "

2

2

| | | |
|--|---------|---------|
| | | |
| | 2 | 30 |
| | | 1 30 40 |
| | Offi ce | 4 |
| | | 30 |
| | 30 | 2 |

3

90

4

| | | | | |
|-------|----|--|-------|---|
| | | | | |
| (20) | 5 | | 5 | 0 |
| | 5 | | 1 | |
| | 10 | | 4 5 5 | |

| | | | |
|----------|----|--|------------------|
| (80) | 15 | | 8 7 |
| | 15 | | 8 7 |
| | 15 | | 5 5 5 |
| | 20 | | 5 5 5 5 |
| | 15 | | 5 10 |

14.

5-14

1

UPS

1907

UPS

34

2400

16

610

UPS

:

1.

UPS

3

;

8

1h

20

90

UPS

180

24h

"

"

UPS

"

"

"

"

2.

UPS

"

" UPS

3.

UPS

"

"

"

"

4.

UPS

"

"

"

"

"

"

UPS

4.

UPS

"

"

"

"

UPS

UPS

UPS

2

2

| | | |
|--|---|----|
| | | |
| | 2 | 30 |

| | | | | |
|--|--------|----|----|--|
| | 1 | 30 | 40 | |
| | Office | 4 | | |
| | | 30 | | |
| | 30 | 2 | | |

3

90^o

4

5

5

1

5

(20)

4

5

0

10

5

15

8

7

(80
)

| | | | | |
|--|----|--|-------------|--|
| | 20 | | 5 5 5 | |
| | 15 | | 5 10 | |

15.

5-15

1

1990

2004

www.ejctrans.com

4000204446

2004

200

2007

"

"

6000

1990

3

200

300

4000204446

— www.ejctrans.com

"

24

"

1)

18

2

2

2

| | | |
|--|----------|-------|
| | | |
| | 2 | 30 |
| | 1 | 30 40 |
| | Office 4 | |
| | 30 | |
| | 30 | 2 |

3

90

4

| | | | | |
|-------|----|--|---|---|
| | | | | |
| (20) | 5 | | 5 | 0 |
| | 5 | | 1 | |
| | 10 | | 4 | |
| | | | 5 | |

(80
)

| | | | | |
|--|----|--|------------------|--|
| | 15 | | 8 7 | |
| | 15 | | 8 7 | |
| | 15 | | 5 5 5 | |
| | 20 | | 5 5 5 5 | |
| | 15 | | 5 10 | |

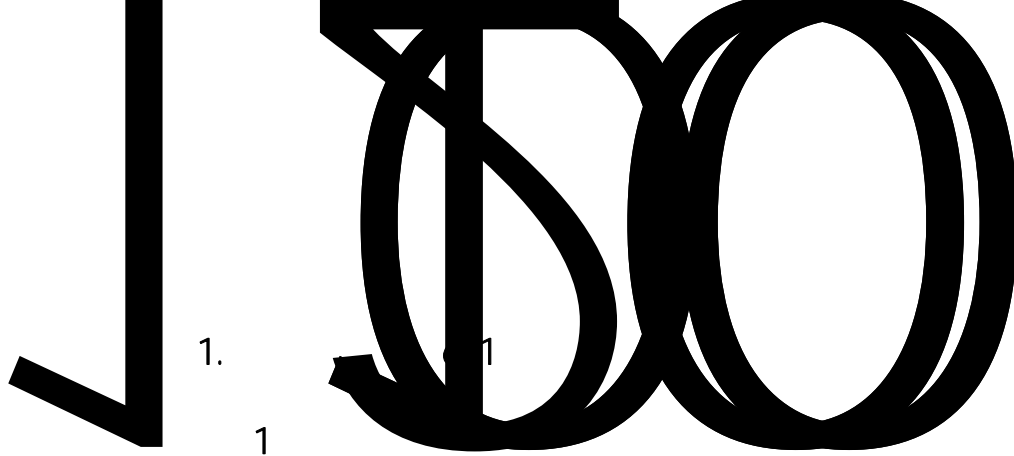

1.

1

1

2013 11 29

2013 12 20

11 29

3

2013 11 30

MP4

è è

| | | |
|--|----|---|
| | 1 | |
| | 10 | 8 |

2

2

| | | |
|--|---------|---------|
| | | |
| | 1 | 30 |
| | | 1 30 40 |
| | Offi ce | 5 |
| | | 30 |
| | 30 | 2 |

3

90

4

| | | | | |
|-------|----|--|--------|---|
| | | | | |
| (20) | 10 | | 5 | 0 |
| | | | 5 | |
| (80) | 10 | | 5 5 | |
| | 12 | | 8 4 | |
| | 10 | | 7 3 | |

| | | | | |
|--|----|--|---|---|
| | 12 | | 9 | 3 |
| | 6 | | 6 | |
| | 10 | | 8 | 2 |
| | 10 | | 8 | 2 |
| | 20 | | 5 | |

2

6-2

1

1

2012 9

6 300

"

"

5 250

5

500

500

15000

50cm 40cm 60cm 5kg

8

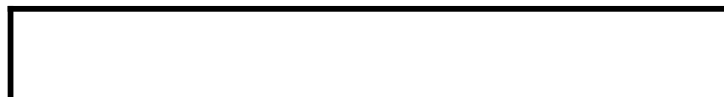

| | | |
|--|----|---|
| | 1 | |
| | 10 | 8 |

快运详情单
EXPRESS WAYBILL

0 2 0 0 0 0 5 6 1 7 6 0 3

| | | | |
|----------------------------------------------------------------|---------------------------------------------------------------|-----------------------------------------------------------------------------------------------------------------------------|--------------------------------|
| 寄件人: 陈市伟 Send By: 陈市伟 | 始发地: 广州天河 Origin: 广州天河 | 收件人: 陈牛伟 Received By: 陈牛伟 | 目的地: 长沙开福 Destination: 长沙开福 |
| 寄件地址: 广东省广州市天河区 From: 广东省广州市天河区 | 收件地址: 海南省长沙市开福区浏阳河大桥东 To: 海南省长沙市开福区浏阳河大桥东 | | |
| 单位: ×××医院保健科 Company: ×××医院保健科 | 单位: 湖南卫视电视台国际频道总监室 Company: 湖南卫视电视台国际频道总监室 | | |
| 电话: 020-868****4 Tel: 020-868****4 | 手机: 1386****3886 Mobile: 1386****3886 | 电话: 0731-82***6808 Tel: 0731-82***6808 | 手机: Mobile: |
| 请您在签字前阅读背书条款, 贵重物品请保价未保价物品的理赔为资费的5倍。 | | | 件数: |
| 发件人 姓名: 月 日 时 | 揽件人 姓名: 月 日 时 | 收件人 姓名: 月 日 时 | 重量: |
| 内件说明: <input type="checkbox"/> 货样 <input type="checkbox"/> 非货样 | 付款方式: <input type="checkbox"/> 现付 <input type="checkbox"/> 月结 | <input type="checkbox"/> 本人签收 <input type="checkbox"/> 同事签收 <input type="checkbox"/> 家属签收 <input type="checkbox"/> 其他人签收 | 资费: |
| 0200005617603 | | 备注: | 总资费: |

2

2

| | | |
|--------|----|-------|
| | | |
| | 1 | 30 |
| | 1 | 30 40 |
| Office | 5 | |
| | 30 | |
| 30 | 2 | |

3

90

4

| | | | | |
|-------|----|--|--------|---|
| | | | | |
| (20) | 10 | | 5 | 0 |
| | 10 | | 5 5 | |
| 80 | 12 | | 9 3 | |
| | 12 | | 3 | |
| | 9 | | 3 | |
| | 9 | | 3 | |
| | 10 | | 8 2 | |
| | 8 | | 6 2 | |
| | 20 | | 4 | |

3.

6-3

1

1

2014 9

500

10

8

2

15 /

10

14 /

2014 9 12

3

2014

2

2

| | | |
|--|--------|---------|
| | | |
| | 1 | 30 |
| | | 1 30 40 |
| | Office | 5 |
| | | 30 |
| | 30 | 2 |

3

90

4

| | | | |
|-------|----|--|---|
| | | | |
| (20) | 10 | | 5 |
| | | | 5 |

| | | | | | |
|------|--|----|----|-----|-----|
| | | 10 | | 5 | |
| | | | 7S | 5 | 0 |
| | | 10 | | 8 | 1 |
| | | 5 | | 5 | 1 |
| | | 5 | | 1 | |
| | | | | 1 | |
| | | | | 10 | 4 |
| | | | | | 2.5 |
| | | | | 16 | |
| | | | | 4 | |
| | | | | 4 | 4 |
| | | 40 | | | 4 |
| | | | | | 4 |
| | | | | | 8 |
| | | | | 1 | 8 |
| | | | | | 5 |
| | | | | 6 | |
| | | | | 1.2 | |
| | | | | | 20 |
| | | 20 | | | 1 |
| (80) | | | | | |

4. 6-4

1

1

2010 8 10

60

5

300

10

5 B A 60 40 6000 2
60 40 30 30 18

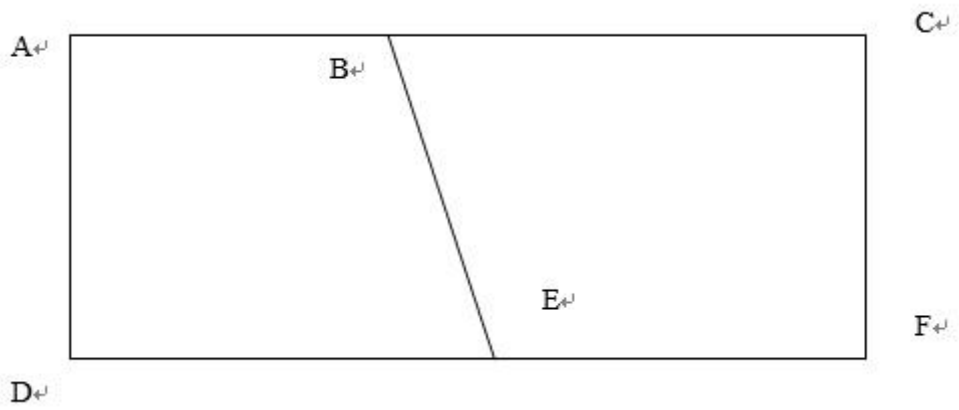

A B 1 C

E F

D

A B 40 B C 40 C F 30

F E 40 E B 30 E D 40 A D

20

2

2

| | | |
|--|---------------------------------|--|
| | | |
| | 1 30 | |
| | 1 30 40 | |
| | Offi ce 5 | |
| | 30 | |
| | 30 2 | |

3

90

4

| | | | | |
|-------|----|--|--------|---|
| | | | | |
| (20) | 10 | | 5 | 0 |
| | 10 | | 5 5 | |
| 80 | 10 | | 2 | |
| | 10 | | 5 | |

| | | | | |
|--|----|--|---|----|
| | 10 | | 1 | 10 |
| | 10 | | 7 | 3 |
| | 10 | | | |
| | 9 | | 3 | |
| | 6 | | 2 | 4 |
| | 15 | | | 5 |

5.

6-5

1

1

125

3500

2 250

?



1-13

2

2

| | | |
|--------|----|---------|
| | | |
| | 1 | 30 |
| | | 1 30 40 |
| Office | 5 | |
| | 30 | |
| 30 | 2 | |

3

90

4

| | | | | |
|--|--|--|--|--|
| | | | | |
|--|--|--|--|--|

| | | | | |
|-------|----|--|---------|---|
| (20) | 10 | | 5 | |
| | 10 | | 5 5 | 0 |
| (80) | 9 | | 3 | |
| | 14 | | 10 4 | |
| | 12 | | 4 | |
| | 10 | | 7 3 | |
| | 10 | | 5 | |
| | 12 | | 3 | |
| | 13 | | | 1 |

6.

6-6

1

1

?

?

2

2

| | | |
|--|--------|---------|
| | | |
| | 1 | 30 |
| | | 1 30 40 |
| | Office | 5 |
| | | 30 |
| | 30 | 2 |

3

90

4

| | | | | |
|-------|----|--|--------|---|
| | | | | |
| (20) | 10 | | 5 | 0 |
| | 10 | | 5 5 | |
| 80 | 10 | | 5 | |
| | 8 | | | |

| | | | | |
|--|----|--|---|---|
| | | | 2 | |
| | 12 | | 4 | |
| | 25 | | 9 | 8 |
| | 9 | | 5 | 4 |
| | 16 | | 4 | |

7. 6-7

1

1

" "

25

7-10

"

" "

"

7 19

"

"

60 cm 40 cm 30 cm

24. 1kg

| | | | | | |
|---|-----|-------|------|-------|------|
| | 1kg | 1kg< | 20kg | 20kg< | 50kg |
| — | 12 | 6 /kg | | 5 /kg | |

| | | | |
|---|----|-------|-------|
| — | 10 | 2 /kg | 1 /kg |
|---|----|-------|-------|

60cm 40cm 30cm

14

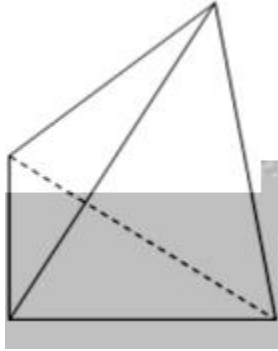

| | | |
|---|------|------|
| — | 20 / | 8 / |
| — | 30 / | 12 / |

2

2

| | | |
|--|--------|---------|
| | | |
| | 1 | 30 |
| | | 1 30 40 |
| | Office | 5 |
| | | 30 |
| | 30 | 2 |

3

90

4

| | | | | |
|-------|----|--|--------|---|
| | | | | |
| (20) | 10 | | 5 | 0 |
| | 10 | | 5 5 | |
| 80 | 25 | | 5 | |
| | 12 | | 3 | |
| | 8 | | 2 | |
| | 10 | | 5 5 | |
| | 10 | | 2 8 | |
| | 15 | | 5 10 | |

8.

6-8

1

1

A

3

A

A

A

?
4CM



4

?

4

2

2

| | | |
|--|----------|--|
| | | |
| | 1 30 | |
| | 1 30 40 | |
| | Office 5 | |
| | 30 | |
| | 30 2 | |

3

90

4

| | | | | |
|-------|----|--|-----|---|
| | | | | |
| (20) | 10 | | 5 | 0 |
| | 10 | | 5 | |
| 80 | 8 | | 2 | |
| | 10 | | 5 | |
| | 10 | | 5 | |
| | 12 | | 3 | |
| | 10 | | 10 | |
| | 20 | | 4 | |
| | 10 | | 2.5 | |

9

6-9

1

1)

2014 3 2 10

3 3

17

3 4

3 4 18

2

2

| | | |
|--|----------|--|
| | | |
| | 1 30 | |
| | 1 30 40 | |
| | Office 5 | |
| | 30 | |
| | 30 2 | |

3

90

4

| | | | |
|-------|----|--|---|
| | | | |
| (20) | 10 | | 5 |

| | | | | | |
|-------|--|----|--|---|---|
| | | | | 5 | |
| | | 10 | | | 0 |
| (80) | | 10 | | 5 | |
| | | 15 | | 7 | 8 |
| | | 20 | | 4 | |
| | | 15 | | 7 | 8 |
| | | 20 | | 4 | |

10.

6-10

1

1

| | | | | | |
|--|--|-----|------------------|--------|--|
| | | | | | |
| | | | 0351-69454 19 | 030025 | |
| | | 23 | 139788188 | 530012 | |
| | | 139 | 0871-31733 16 | 650011 | |

4

A

B

C

D

2

2

1

30

1

30 40

Offi

| | | |
|--|--|--|
| | | |
|--|--|--|

3

90

4

| | | | | |
|-------|----|--|---|---|
| | | | | |
| (20) | 10 | | 5 | 0 |
| | 10 | | 5 | |
| (80) | 9 | | 3 | |
| | 12 | | 4 | |
| | 10 | | 2 | |
| | 16 | | 4 | |
| | 18 | | 3 | |
| | 15 | | 3 | |

11.

6-11

1

1

2011 1 2

1 7

"

"

"

"

"

13823417685

"

"

"

5

"

"

"

"

2

"

"

"

"

"

"

"

Q

"

"

"

"

"

"

"

"

"

2

2

| | | |
|--|----------|--|
| | | |
| | 1 30 | |
| | 1 30 40 | |
| | Office 5 | |
| | 30 | |
| | 30 2 | |

3

90

4

| | | | | |
|-------|----|--|---|--|
| | | | | |
| (20) | 10 | | 5 | |
| | | | 5 | |

| | | | | | |
|-------|--|----|--|----|----|
| | | 10 | | 5 | 0 |
| | | | | 5 | |
| (80) | | 30 | | 15 | 10 |
| | | | | 5 | |
| | | 15 | | 5 | |
| | | | | | |
| | | 20 | | 10 | |
| | | | | | |
| | | 15 | | 5 | |
| | | | | | |

12

6-12

1

1

2011 1 2

1 7

"

"

"

"

"

13823417685

"

"

"

5

"

"

"

"

"

"

"

"

"

"

"

Q

"

"

"

"

"

"

"

"

"

2

2

| | | |
|--|--------|-------|
| | | |
| | 1 | 30 |
| | 1 | 30 40 |
| | Office | 5 |
| | | 30 |
| | 30 | 2 |

3

90

4

| | | | | |
|-------|----|----|---|---|
| | | | | |
| (20) | 10 | | 5 | 0 |
| | | | 5 | |
| (80) | 10 | | 5 | 5 |
| | | | 5 | |
| (80) | 6 | | 2 | |
| | | 12 | | |

| | | | |
|--|----|--|---|
| | | | 4 |
| | 6 | | 2 |
| | 20 | | |
| | 16 | | 4 |
| | 20 | | 5 |

A

11 29

| | | | |
|--|--------|----|----|
| | 1 | 30 | 40 |
| | Office | 5 | |
| | | 30 | |
| | 30 | 2 | |

3

90

4

10

5

5

(20)

10

5

5

0

10

20

10

10

5

40

40

(80)

1

11 23

11 24

45KG

0.3

11 25

11 26

12 3

12 6

11 25

11 26

?

2

2

| | | |
|--|----------|--|
| | | |
| | 1 30 | |
| | 1 30 40 | |
| | Office 5 | |

| | | |
|----|----|--|
| | 30 | |
| 30 | 2 | |

3

90

4

| | | | | |
|-------|----|----|------|---|
| | | | | |
| (20) | 10 | | 5 | 0 |
| | 10 | 7S | 5 | |
| (80) | 20 | | 20 | |
| | | | 1 | |
| | 10 | | 1 | |
| | 20 | | 6 10 | |
| | | | 2 10 | |
| | 30 | | 10 6 | |
| | | | 2 | |
| | | | 20 | |
| | | | 1 | |



2014

9

25

735

3

0231234567

11



0241234567

234

10

10

2

2

1

30

1

30 40

Ofi ce

5

30

30

2

i

m

m'

| | | | | |
|-------|----|----|--------------|---|
| | | | | |
| (20) | 10 | | 5 | 0 |
| | 10 | 7S | 5 | |
| (80) | 40 | | 20 20 | |
| | 10 | | 5 10 1 | |
| | 10 | | 1 | |
| | 20 | | 10 10 | |